

Grundfos Technical Institute



What is Inverter Duty Anyway?

Presenter: Reece Robinson

Feb 22, 2018

www.grundfos.us/training

Grundfos Technical Institute

www.grundfos.us/training

- Virtual Classroom
 - Self-Paced
 - Over 50 courses
 - Certificates of Completion
- Webinars
 - Live and Recorded
- Face-to-Face Training

The screenshot displays the Grundfos Technical Institute website. At the top, there is a dark blue header with the Grundfos logo on the left and 'Language (en) | Logout' on the right. Below this is a navigation bar with links for 'Home', 'Training Catalog', 'us.Grundfos.com', 'Contact', and 'Help', along with a search bar. A 'My Profile' link with a user icon is also present. The main content area features a large blue banner with the text 'Grundfos Technical Institute'. Below the banner are four image-based tiles: 'Virtual Classroom' (showing a laptop), 'Webinars' (showing two people in a meeting), 'Face-to-Face Training' (showing a group of people), and 'Training Calendar' (showing a calendar). A 'Browse Training by Segment' dropdown menu is visible. Below this menu are six image-based tiles representing different training segments: 'Commercial HVAC & Systems', 'Residential Hydronics & Systems', 'Fire Pumps & Systems', 'Commercial Plumbing Systems', 'Residential Plumbing Systems', and 'Municipal Water & Waste Water Pumps & Systems'.

Presenters:



Presenter: Reece Robinson
Senior Technical Trainer



Moderator: Jim Swetye
Technical Training Manager

What is Inverter Duty Anyway?

Reece Robinson,
Senior Technical Trainer
Grundfos Pumps Corporation

Learning Objectives

- Understand Centrifugal pump control and resulting pump speed
- Understand how torque is affected by pump speed
- What defines an Inverter Duty motor
- What types of **centrifugal pump** motors are suitable for variable frequency drives
- Helpful Tips for specifying motors driven by variable frequency drives

**First a little about pump control and
the resulting pump speeds**

The Affinity Laws

for centrifugal pumps

Flow varies linearly with pump speed

$$\begin{aligned} > \quad \frac{\text{GPM}_1}{\text{GPM}_2} = \frac{\text{RPM}_1}{\text{RPM}_2} > \quad \text{GPM}_2 = \text{GPM}_1 \left(\frac{\text{RPM}_2}{\text{RPM}_1} \right) \end{aligned}$$

Head varies with the square of the pump speed

$$\begin{aligned} > \quad \frac{\text{TDH}_1}{\text{TDH}_2} = \left(\frac{\text{RPM}_1}{\text{RPM}_2} \right)^2 > \quad \text{TDH}_2 = \text{TDH}_1 \left(\frac{\text{RPM}_2}{\text{RPM}_1} \right)^2 \end{aligned}$$

Brake Horsepower varies with the cube of the pump speed

$$\begin{aligned} > \quad \frac{\text{BHP}_1}{\text{BHP}_2} = \left(\frac{\text{RPM}_1}{\text{RPM}_2} \right)^3 > \quad \text{BHP}_2 = \text{BHP}_1 \left(\frac{\text{RPM}_2}{\text{RPM}_1} \right)^3 \end{aligned}$$

When TDH₁, RPM₁ and TDH₂ are known:

$$\text{RPM}_2 = \text{RPM}_1 \sqrt{\frac{\text{TDH}_2}{\text{TDH}_1}}$$

1 = Original condition (full speed)
2 = New condition (reduced speed)

Closed Loop Circulation

Heating and/or Cooling

Differential Pressure control

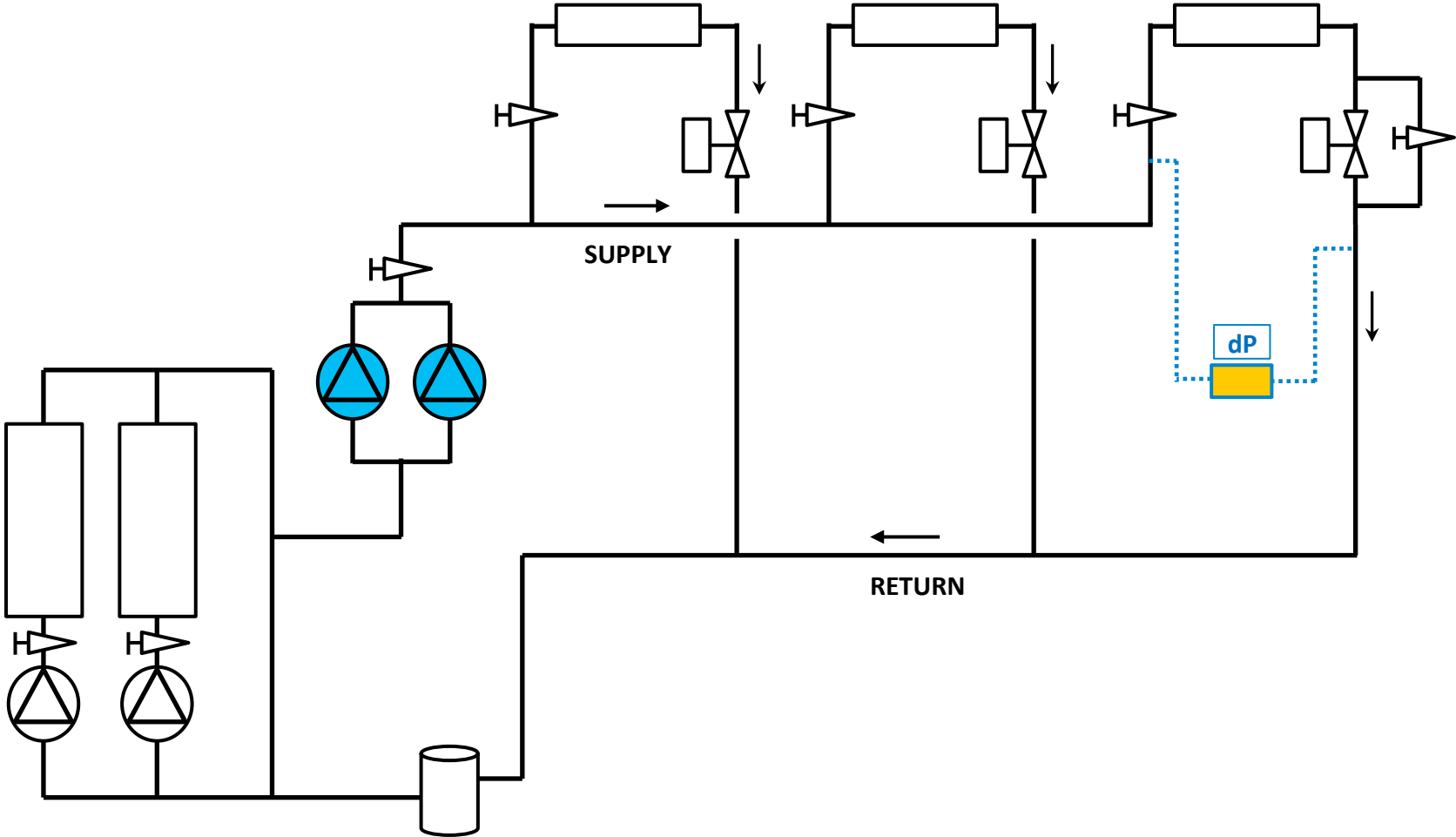

Closed Loop Circulation

Heating and/or Cooling

Differential Pressure control

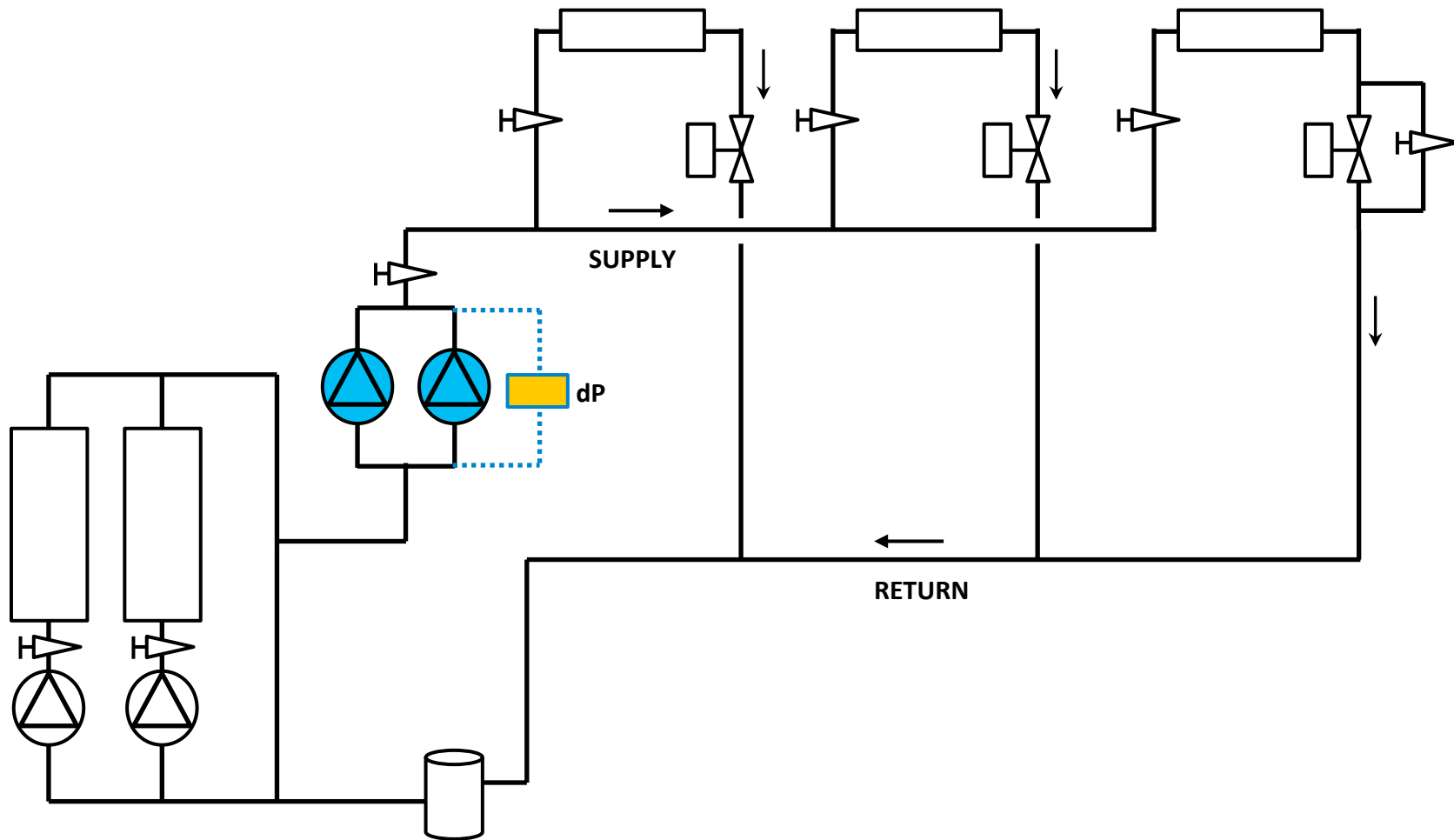

Pressure Boosting

Constant Pressure control

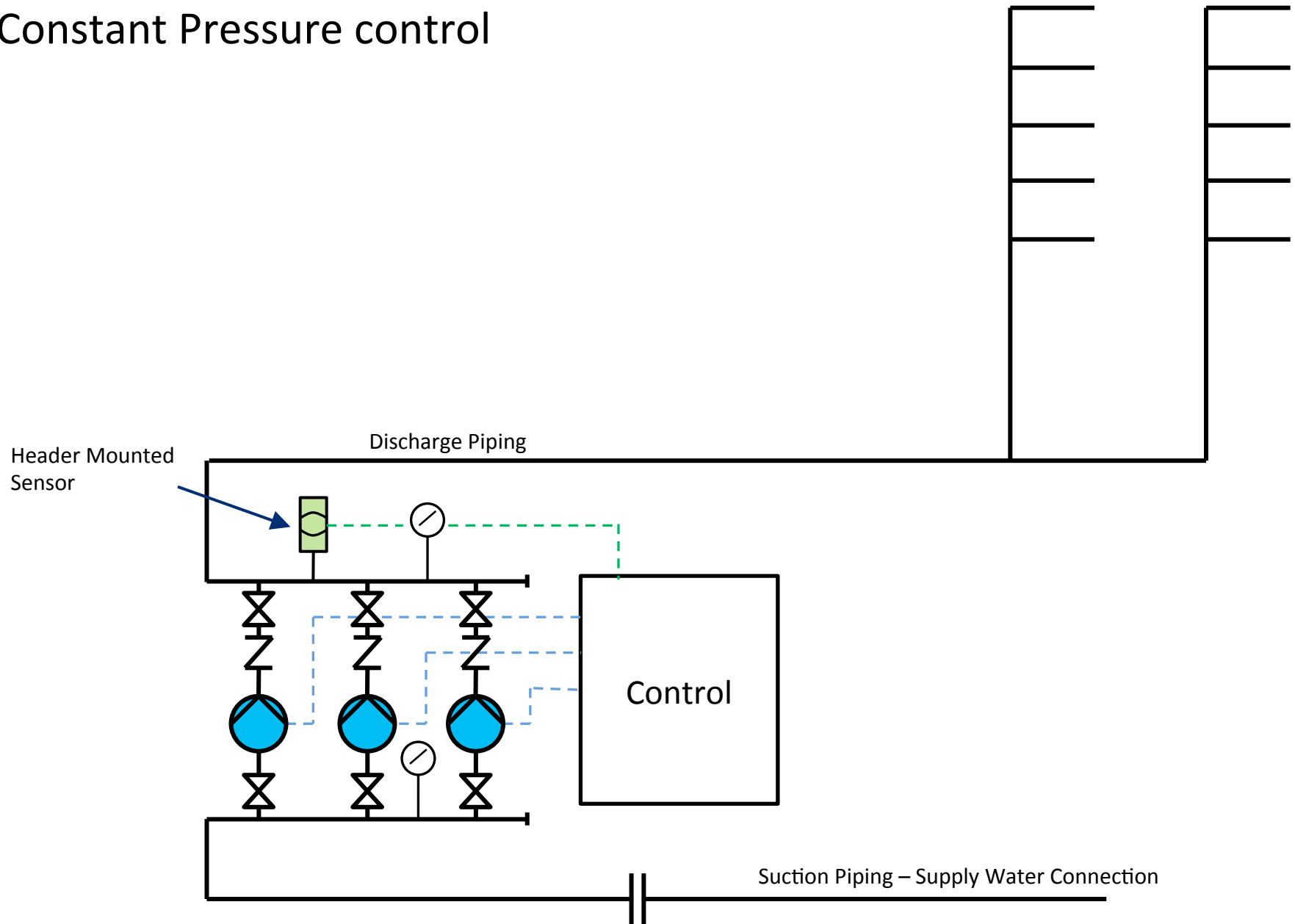

Pressure Boosting

Constant Pressure control

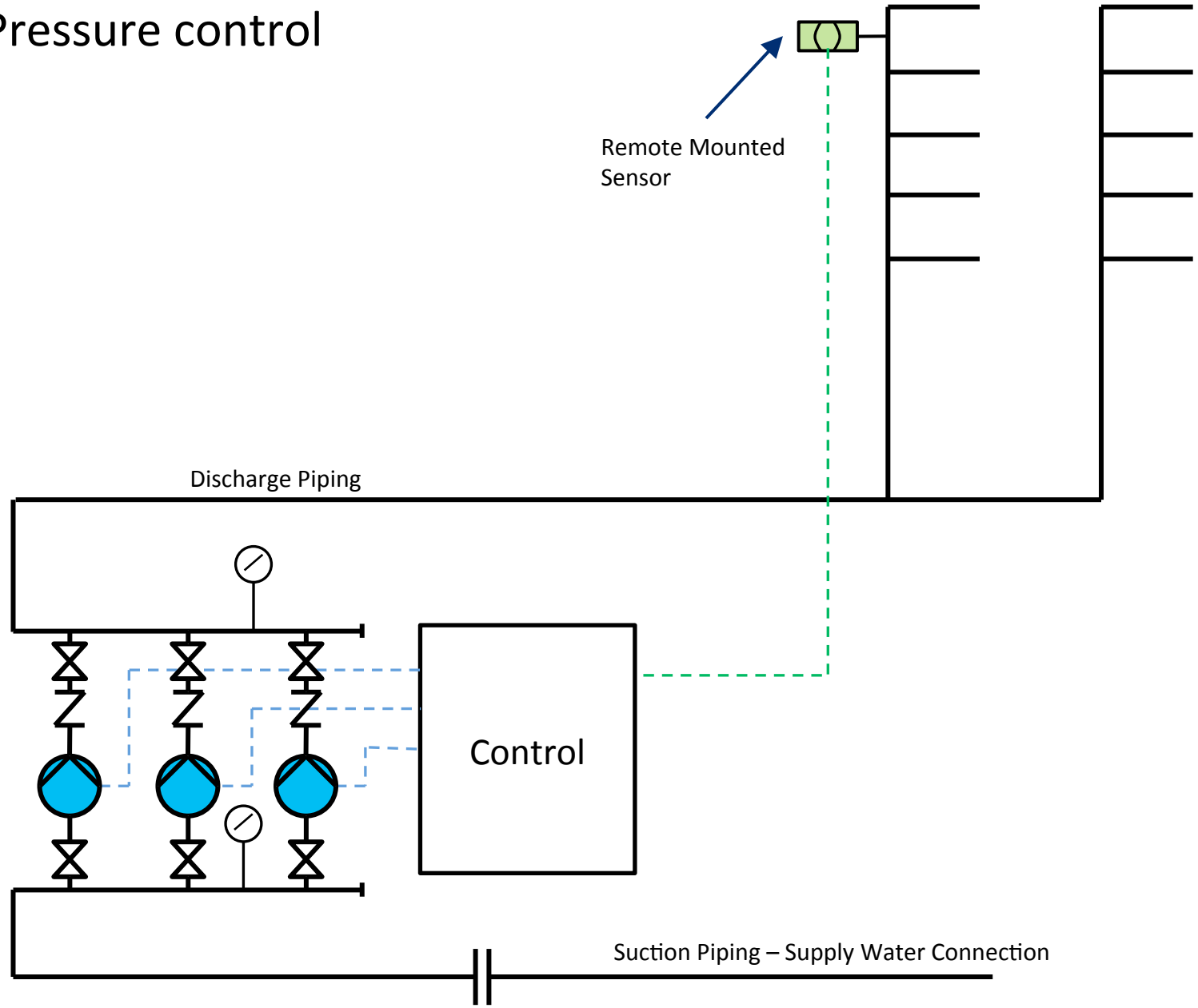

Constant Pressure Control Curve

Frequency Range:
40-60Hz

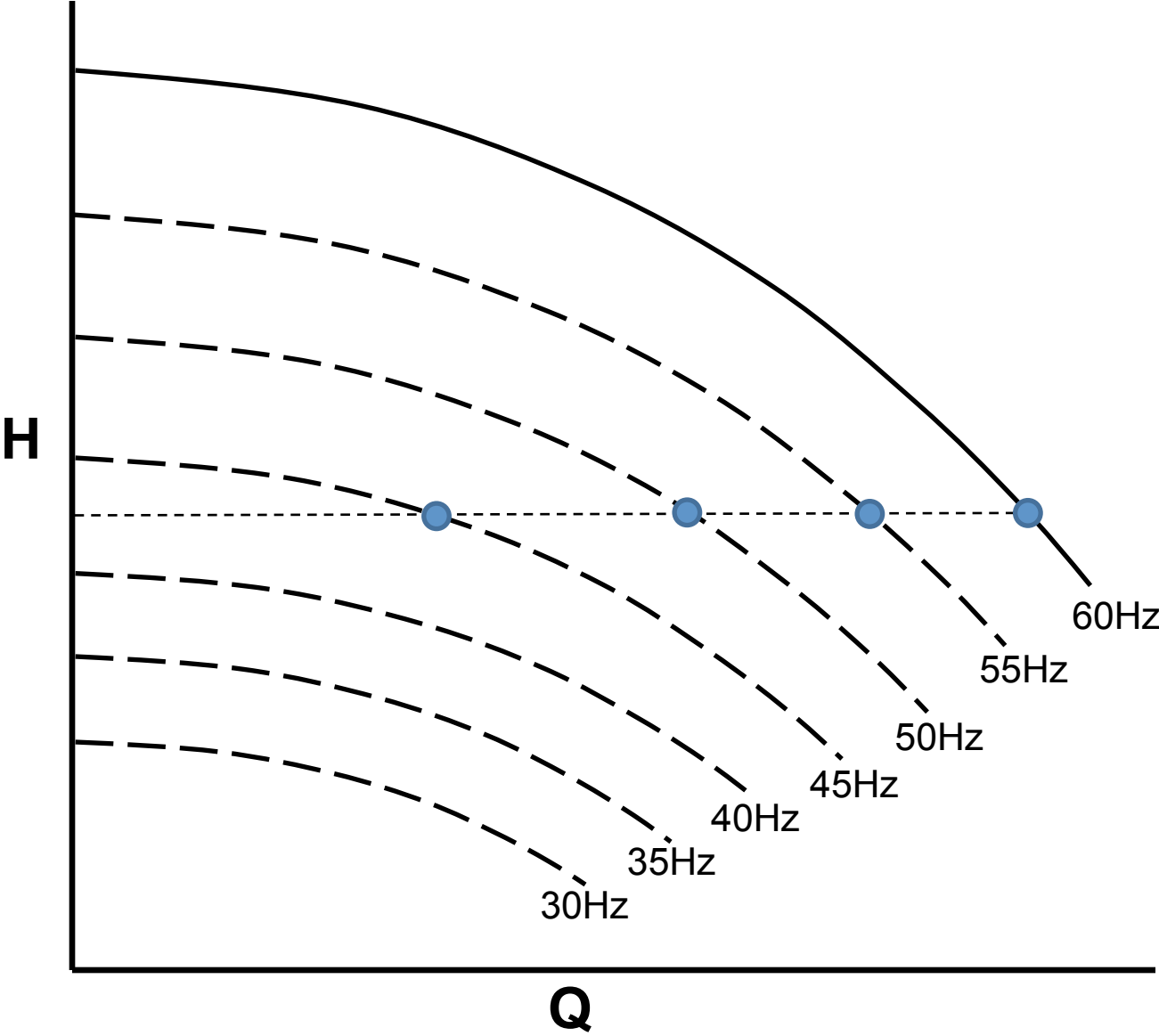

Proportional Pressure Control Curve

Frequency Range:
35-60Hz

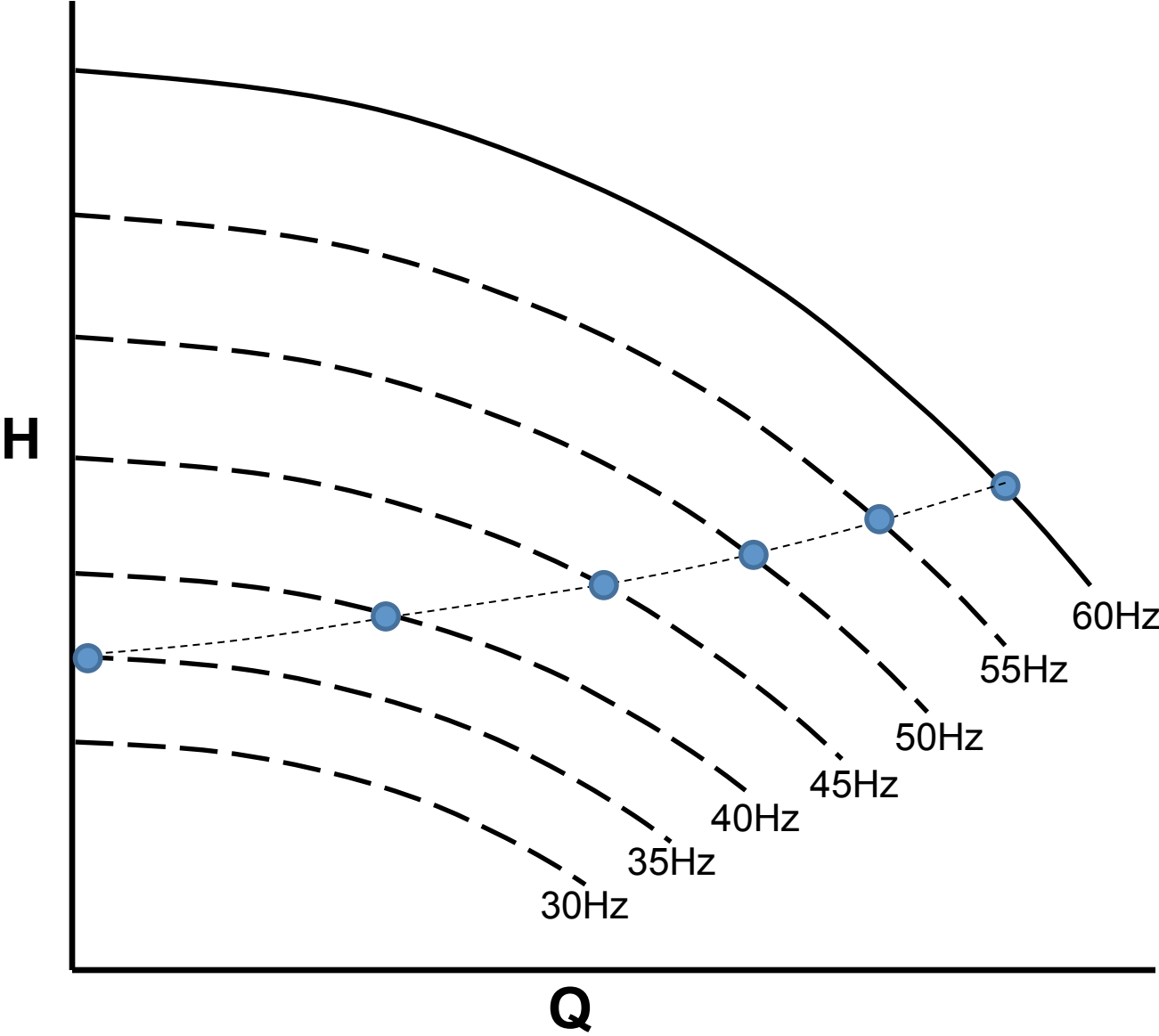

Normal Operating Speed Range

When selecting pumps for variable flow

Select pumps based on a design flow that is to the **RIGHT** of the pumps best efficiency point.

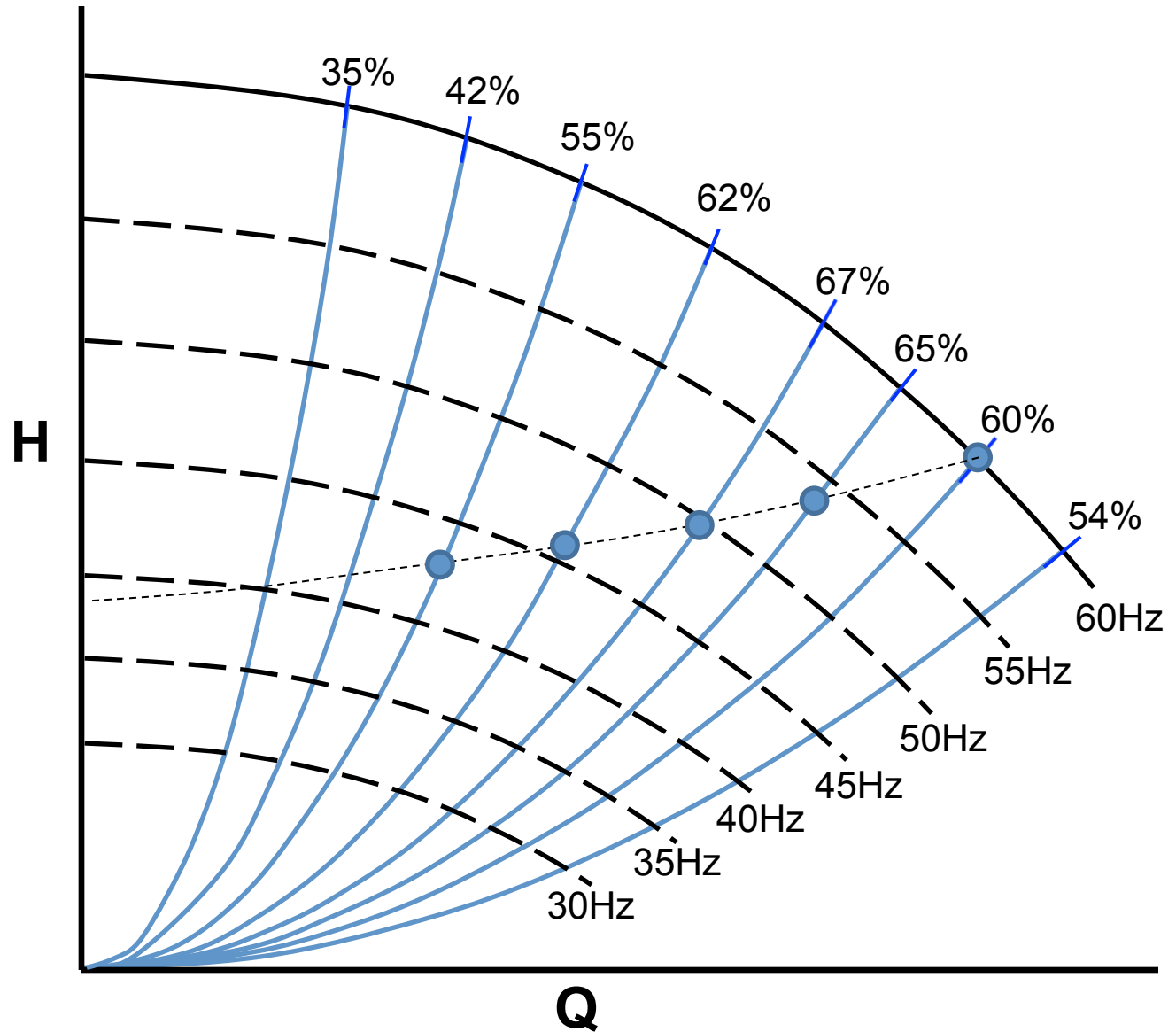

Normal Operating Speed Range

When selecting pumps for variable flow

Select pumps based on a design flow that is to the **RIGHT** of the pumps best efficiency point.

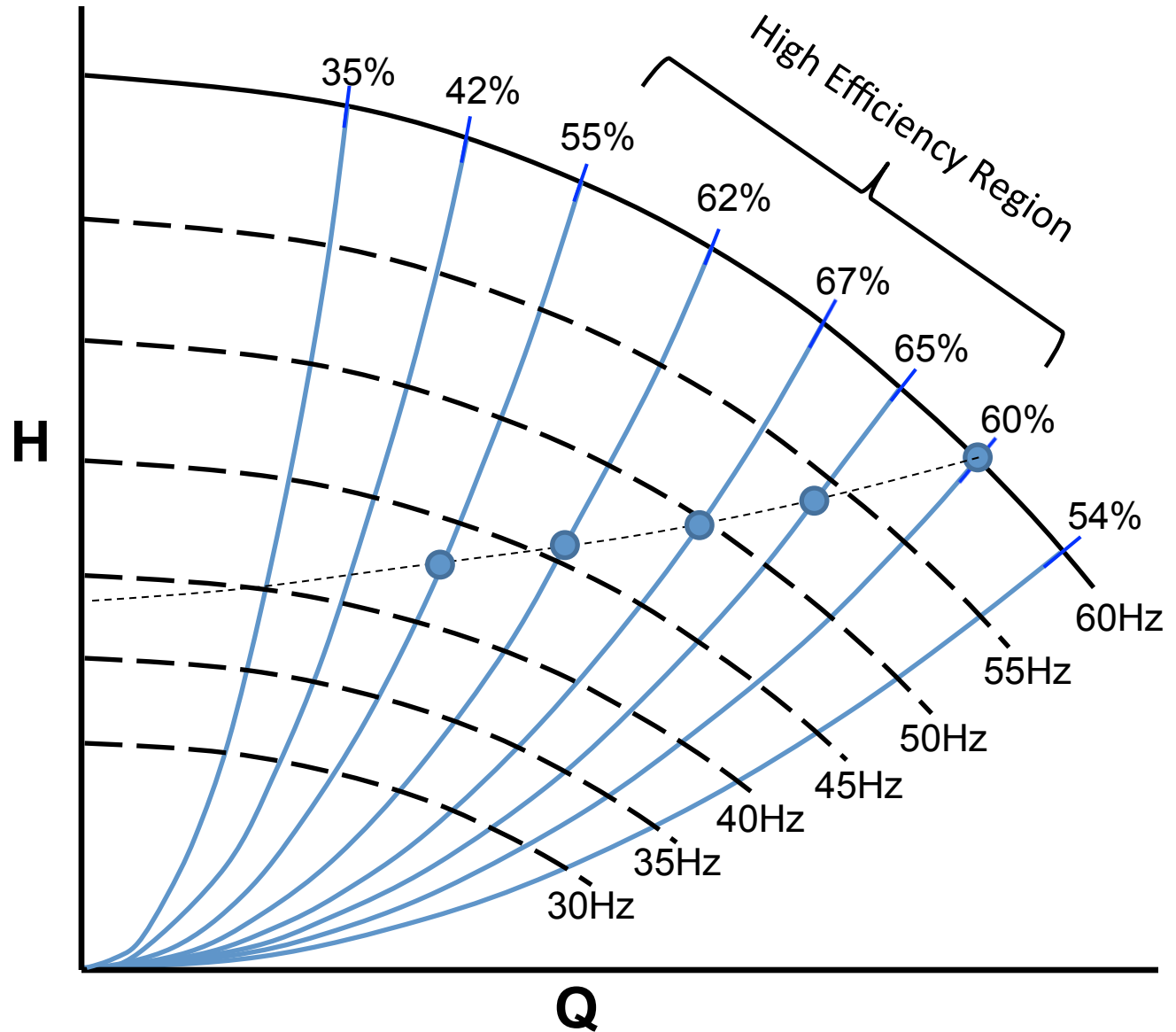

Normal Operating Speed Range

When selecting pumps for variable flow

Select pumps based on a design flow that is to the **RIGHT** of the pumps best efficiency point.

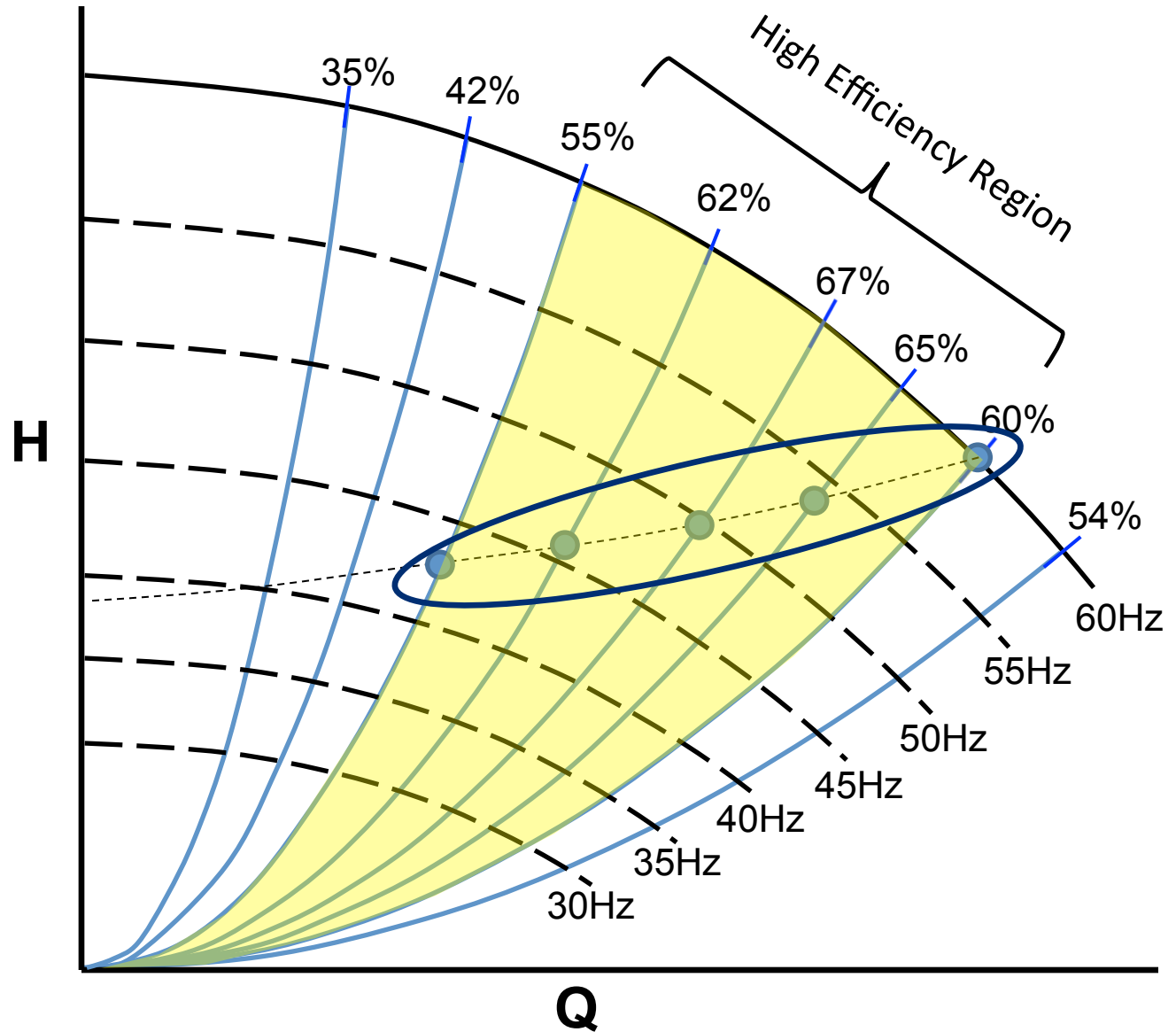

Typical VFD Efficiency Curve

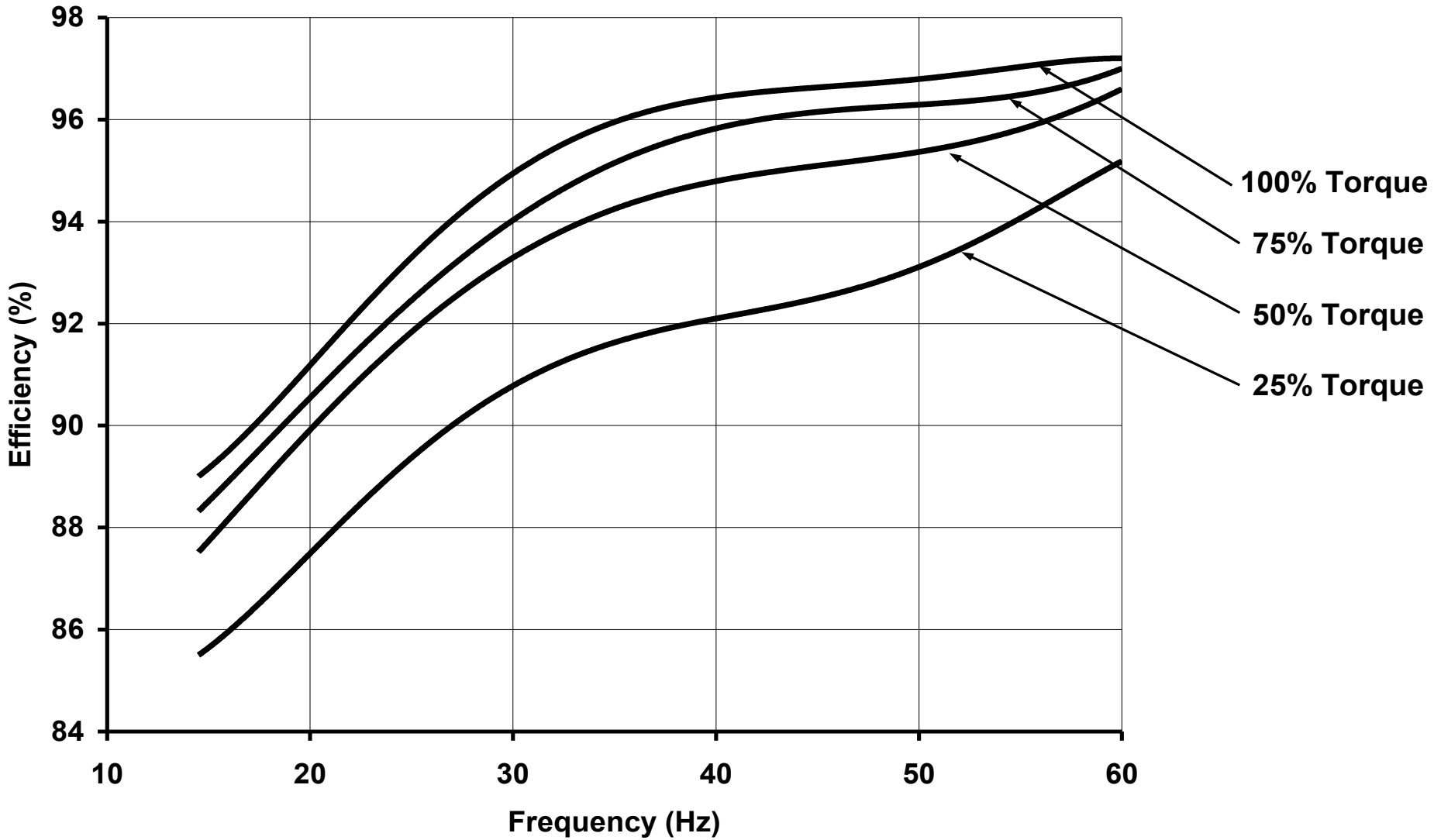

Source: Hydraulic Institute/Europump Guide to Life Cycle Costs

Typical VFD Efficiency Curve

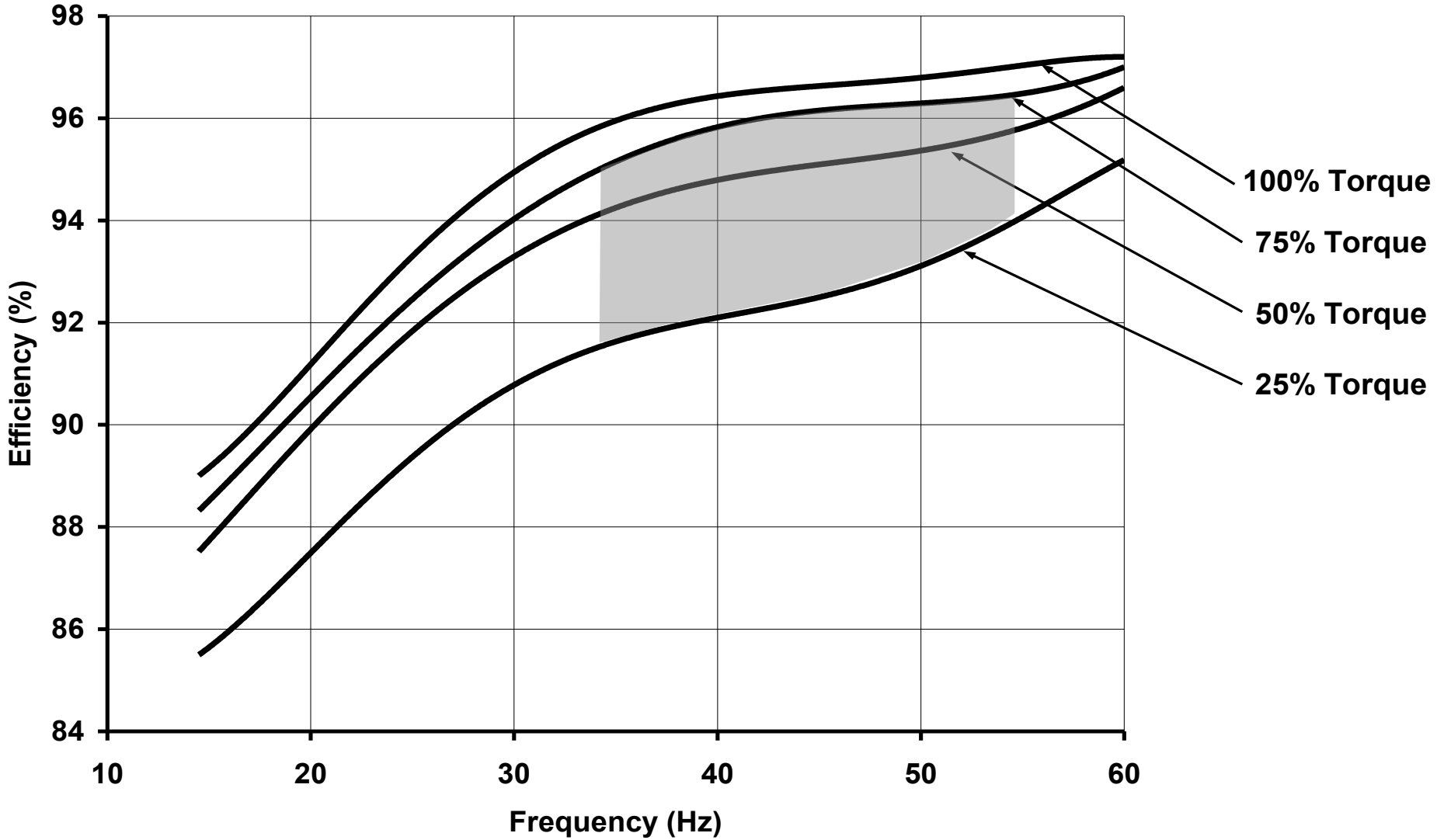

Source: Hydraulic Institute/Europump Guide to Life Cycle Costs

Turndown Ratio

Speed and Torque reduction 4:1 speed ratio

Point A

Full Speed

180 gpm @ 235 feet

BHP = 15

RPM = 3450

Torque = 22.8 lb-ft

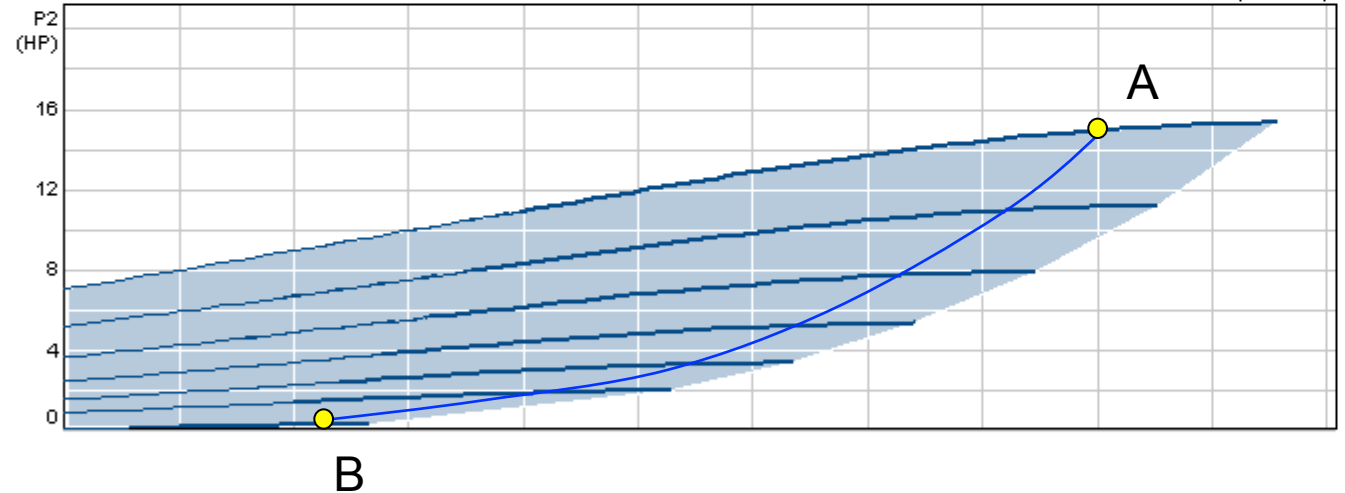
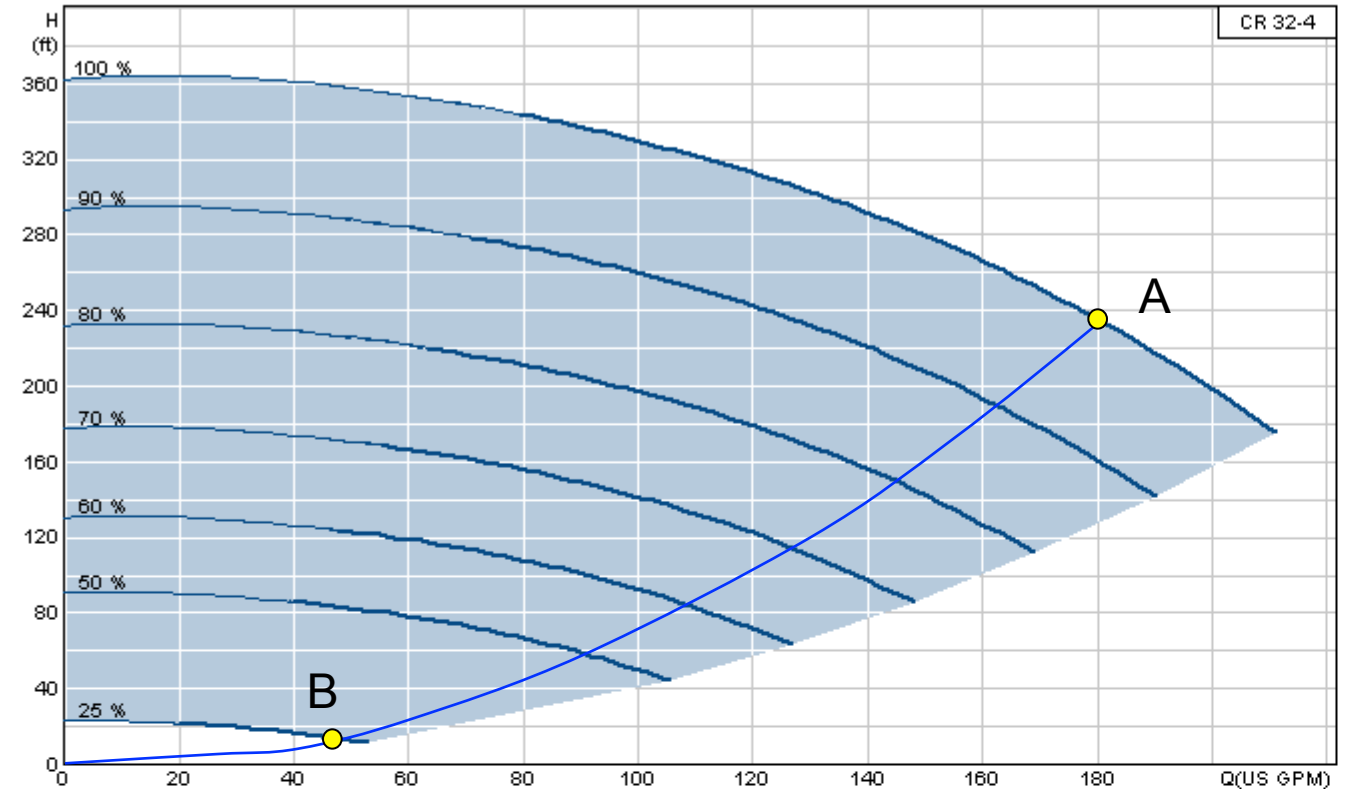

Speed and Torque reduction 4:1 speed ratio

Point A

Full Speed

180 gpm @ 235 feet

BHP = 15

RPM = 3450

Torque = 22.8 lb-ft

Point B

Speed reduced to 25%

45 gpm @ 14.7 feet

BHP = 0.23

RPM = 863

Torque = 1.4 lb-ft

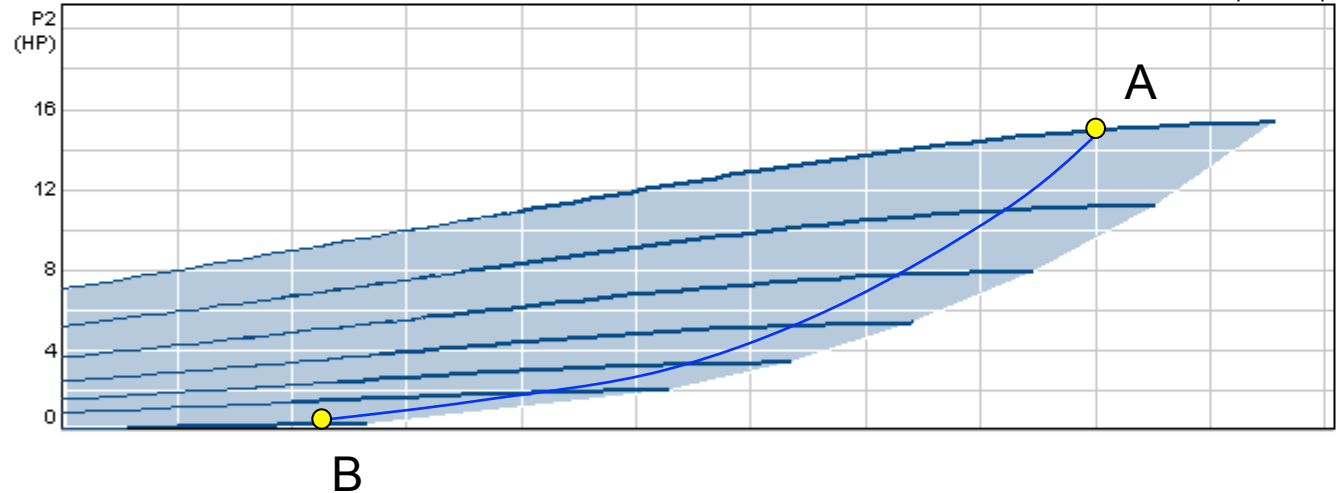
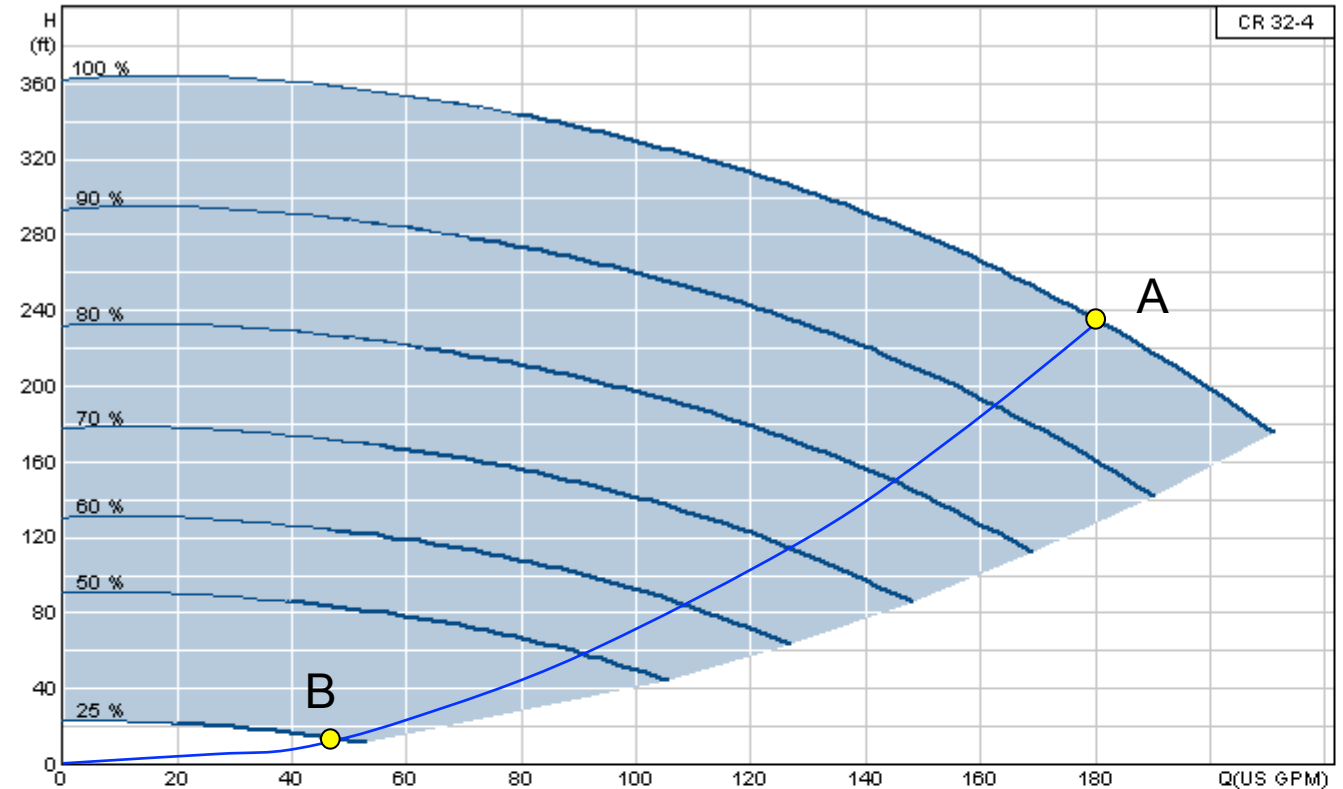

Speed and Torque reduction 4:1 speed ratio

Point A

Full Speed

180 gpm @ 235 feet

BHP = 15

RPM = 3450

Torque = 22.8 lb-ft

Point B

Speed reduced to 25%

45 gpm @ 14.7 feet

BHP = 0.23

RPM = 863

Torque = 1.4 lb-ft

Equation for torque

$$T = \frac{HP \times 5250}{RPM}$$

Speed has been reduced by 75% but Torque has been reduced by **93.9%**

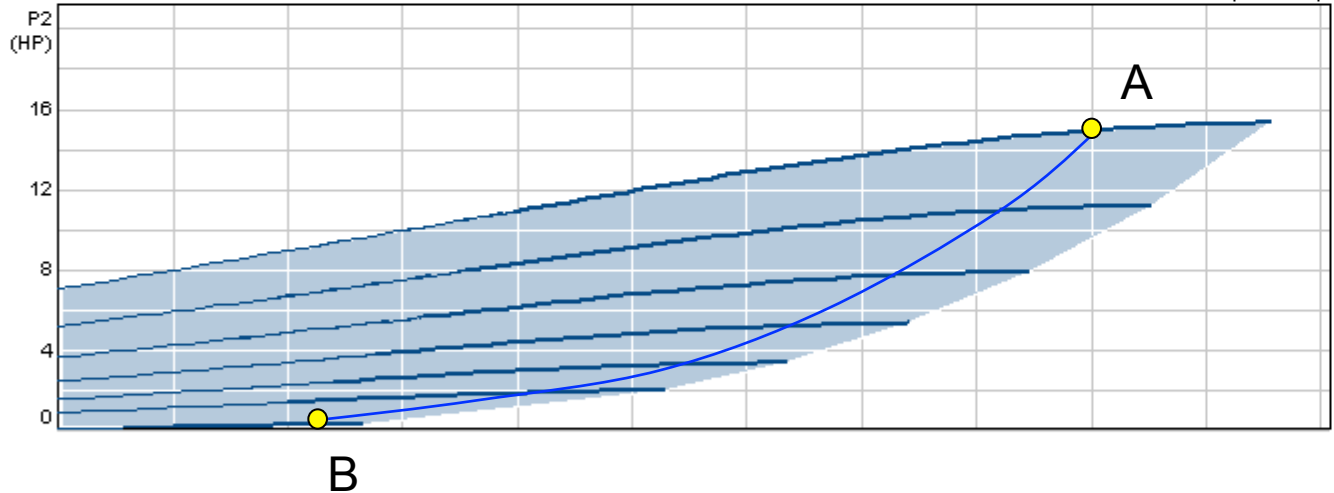
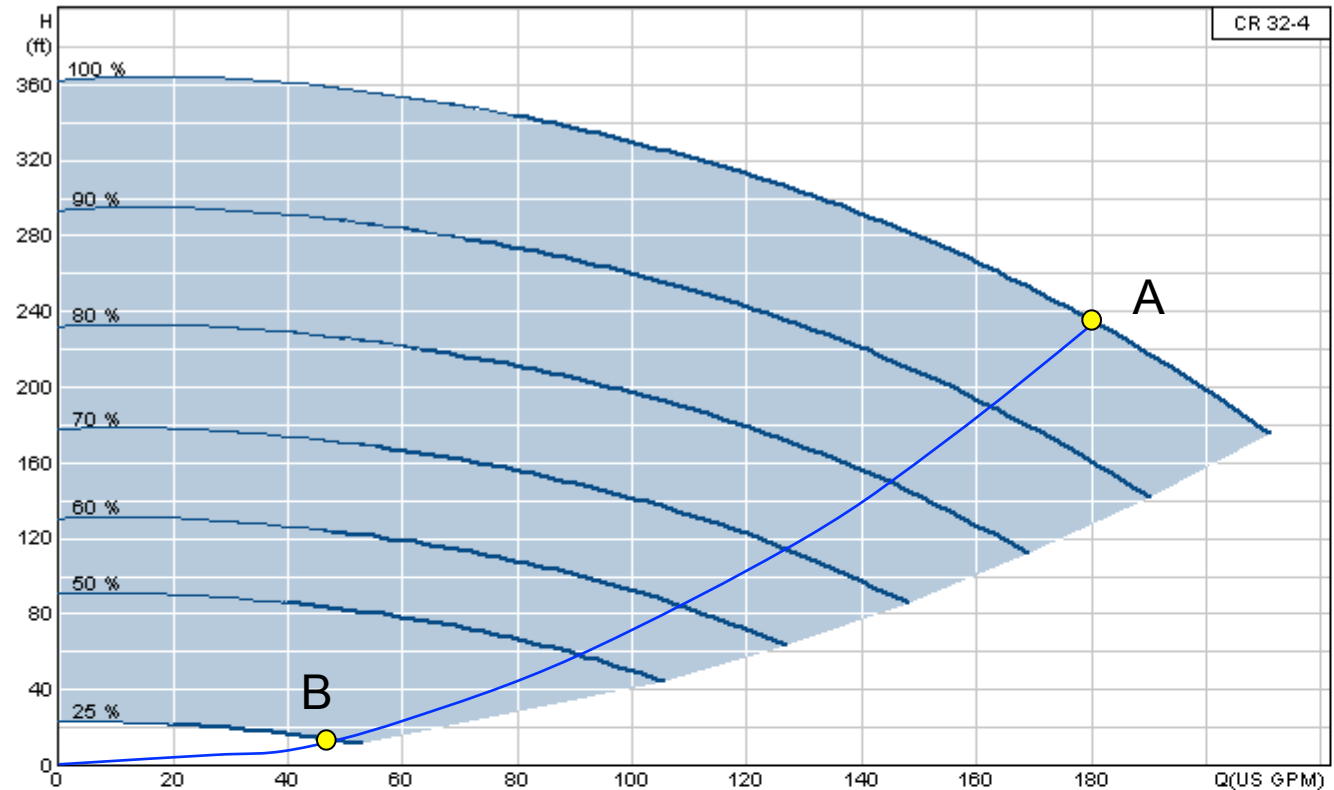

Speed and Torque reduction with constant pressure control

Point A
Full Speed
180 gpm @ 235 feet
BHP = 15
RPM = 3450
Torque = 22.8 lb-ft

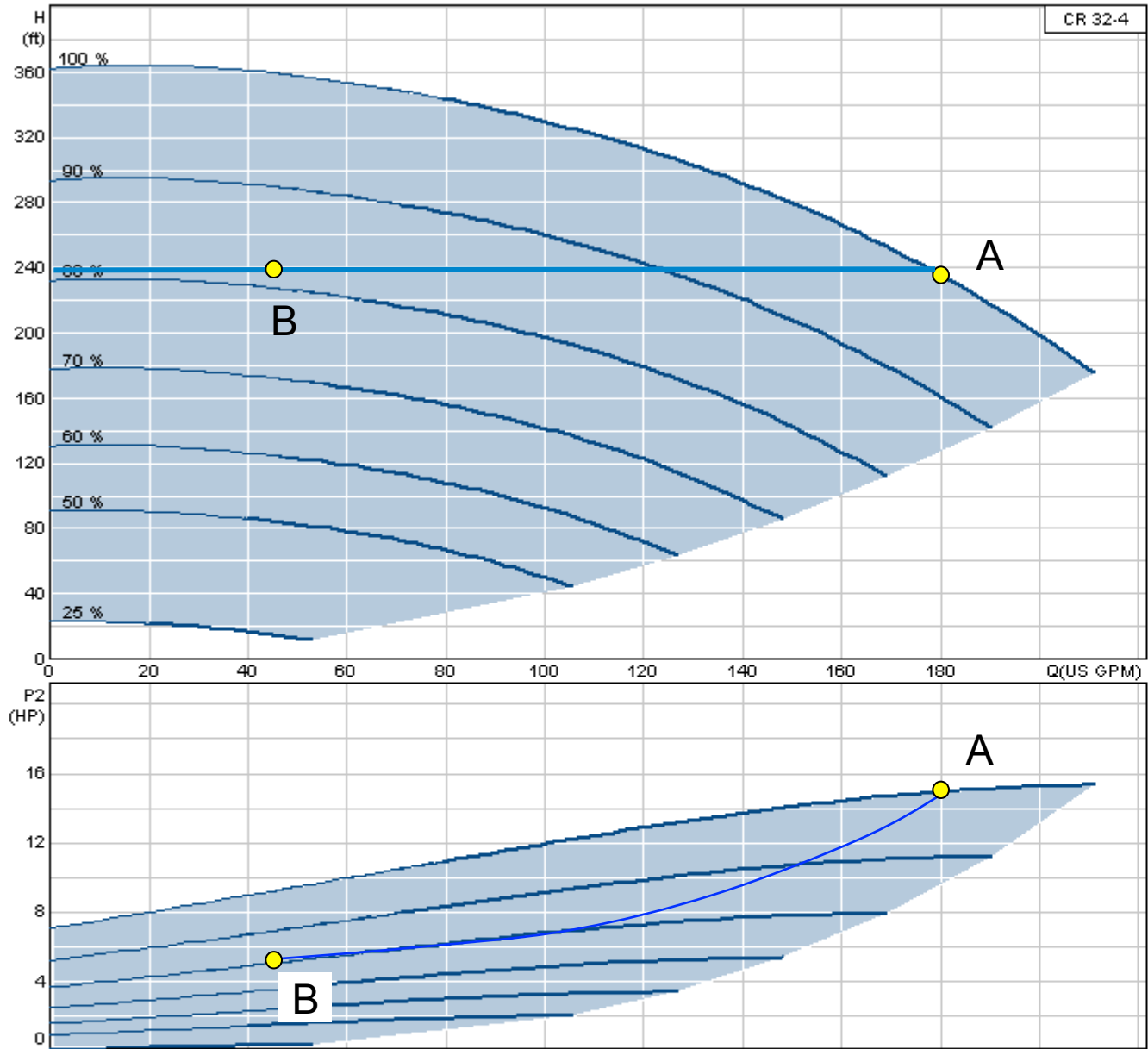

Speed and Torque reduction with constant pressure control

Point A

Full Speed
 180 gpm @ 235 feet
 BHP = 15
 RPM = 3450
 Torque = 22.8 lb-ft

Point B

Speed reduced to 81%
 45 gpm @ 235 feet
 BHP = 5.2
 RPM = 2795
 Torque = 9.8 lb-ft

Equation for torque

$$T = \frac{HP \times 5250}{RPM}$$

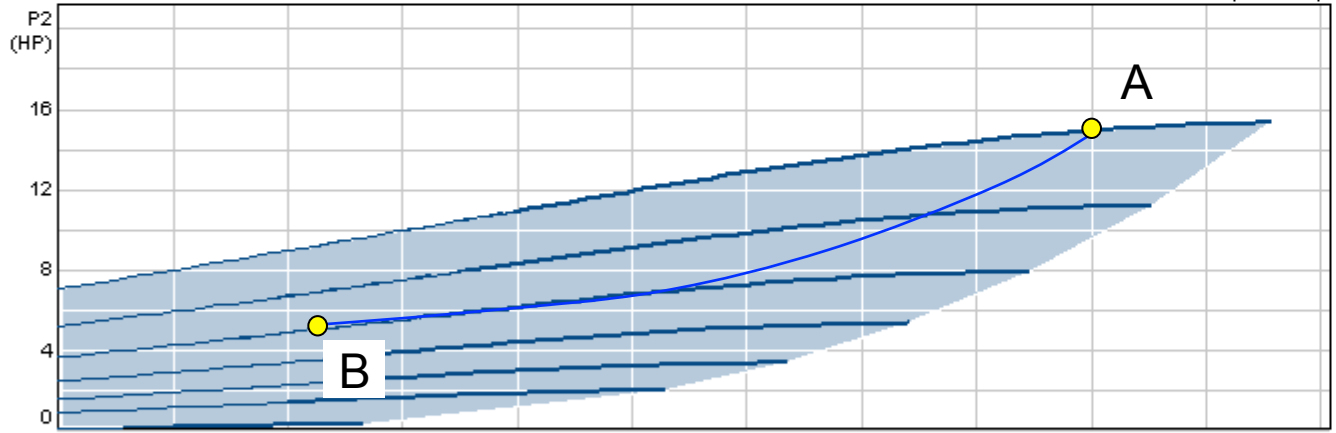
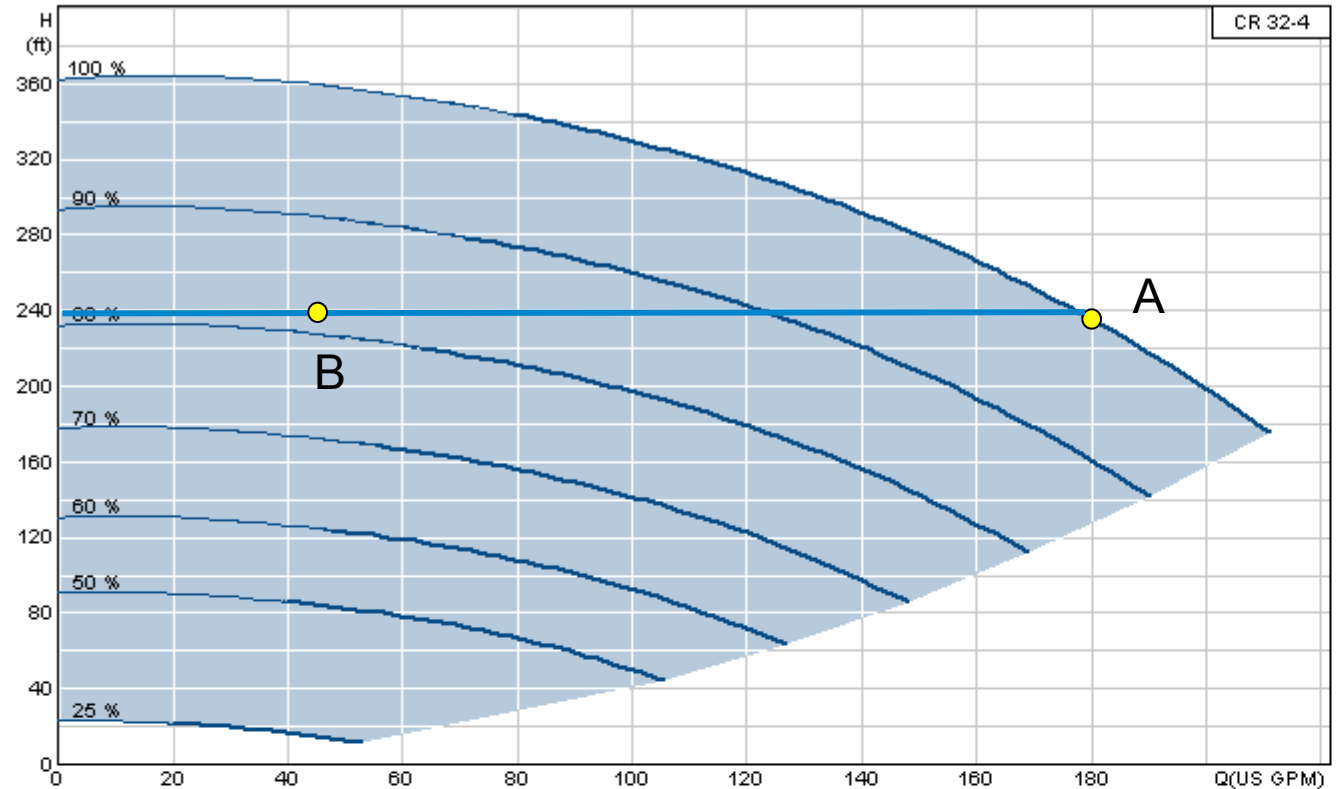

Speed and Torque reduction with constant pressure control

Point A

Full Speed

180 gpm @ 235 feet

BHP = 15

RPM = 3450

Torque = 22.8 lb-ft

Point B

Speed reduced to 81%

45 gpm @ 235 feet

BHP = 5.2

RPM = 2795

Torque = 9.8 lb-ft

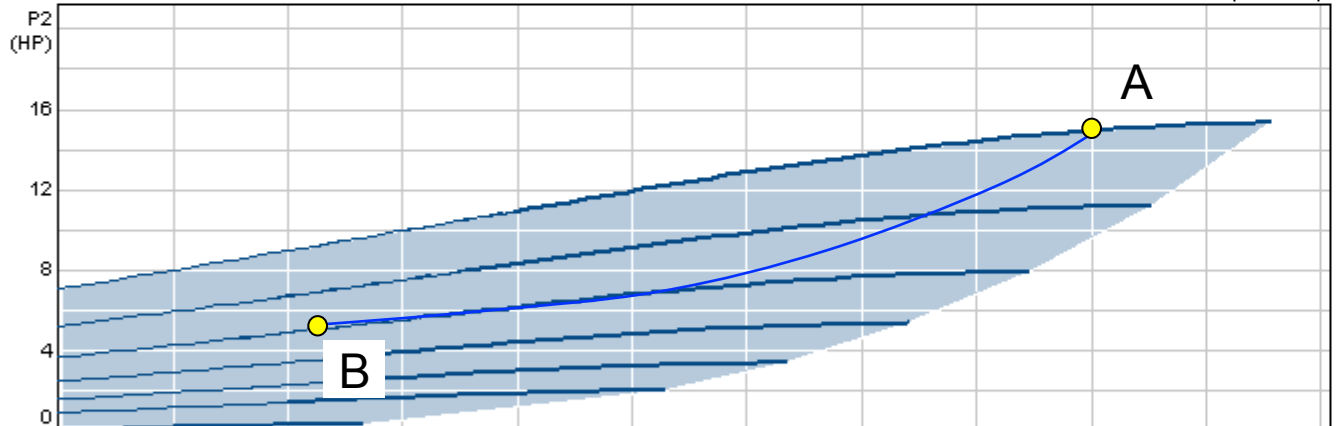
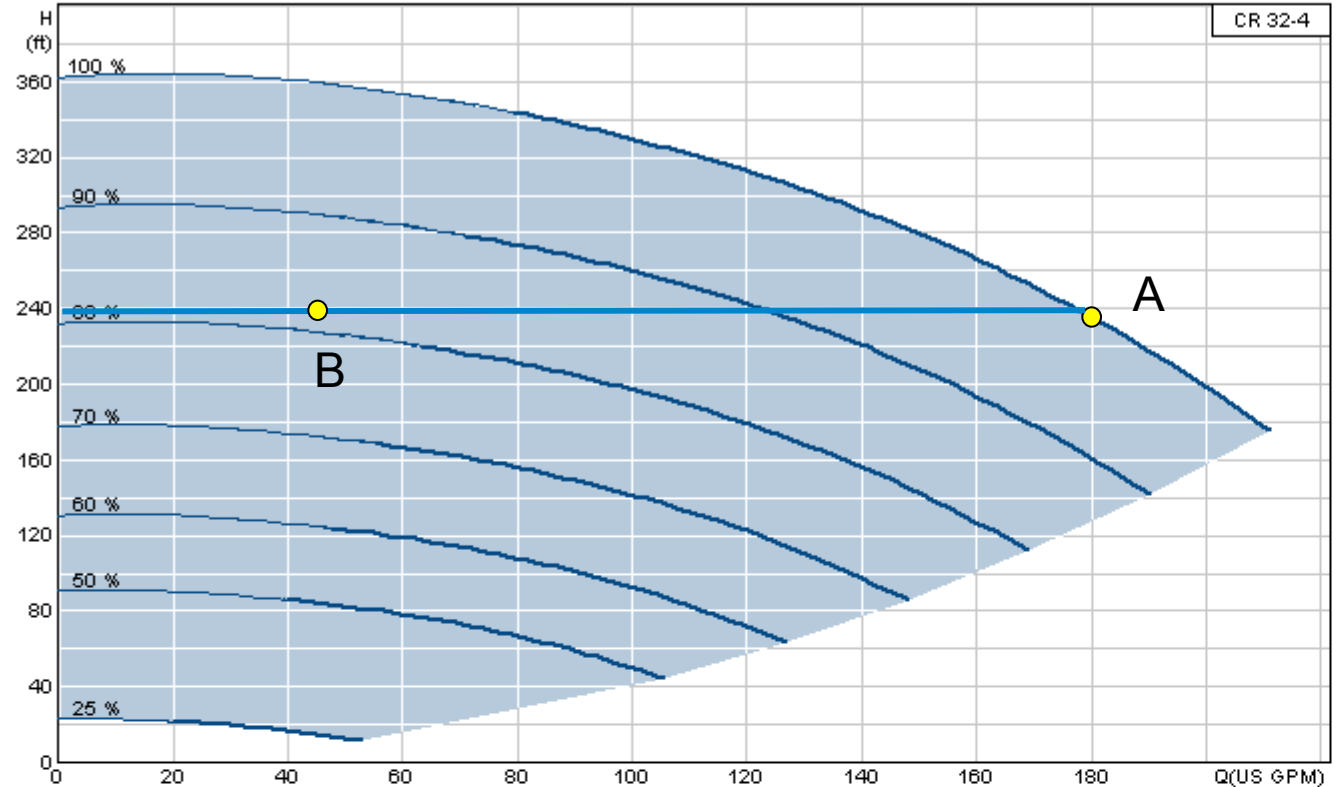

Equation for torque

$$T = \frac{HP \times 5250}{RPM}$$

Speed has been reduced by 19% but Torque has been reduced by 60%

Speed and Torque reduction with **proportional** pressure control

Point A

Full Speed

180 gpm @ 235 feet

BHP = 15

RPM = 3450

Torque = 22.8 lb-ft

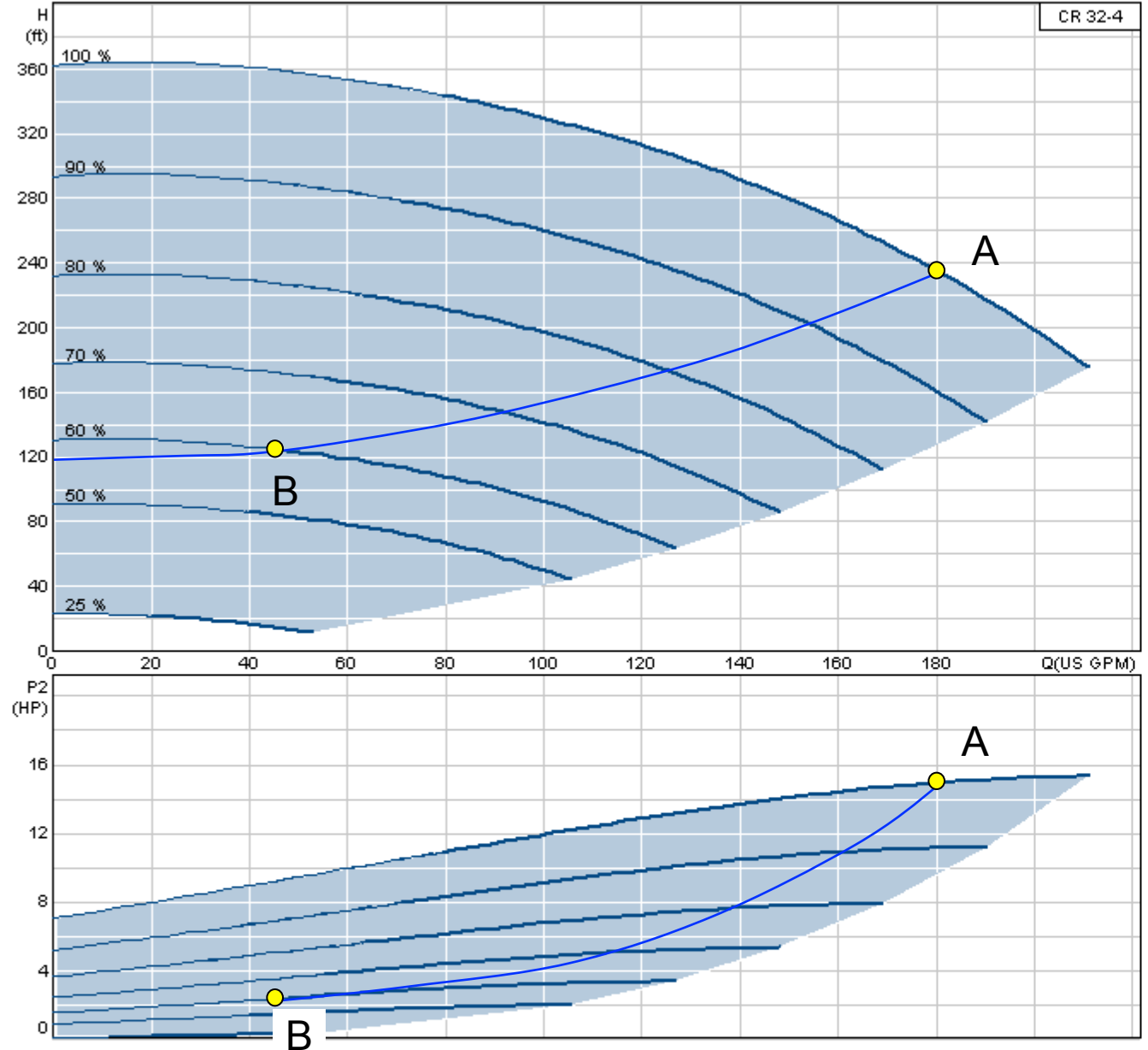

Speed and Torque reduction with **proportional** pressure control

Point A

Full Speed

180 gpm @ 235 feet

BHP = 15

RPM = 3450

Torque = 22.8 lb-ft

Point B

Speed reduced to 60%

45 gpm @ 127 feet

BHP = 2.4

RPM = 2070

Torque = 6.1 lb-ft

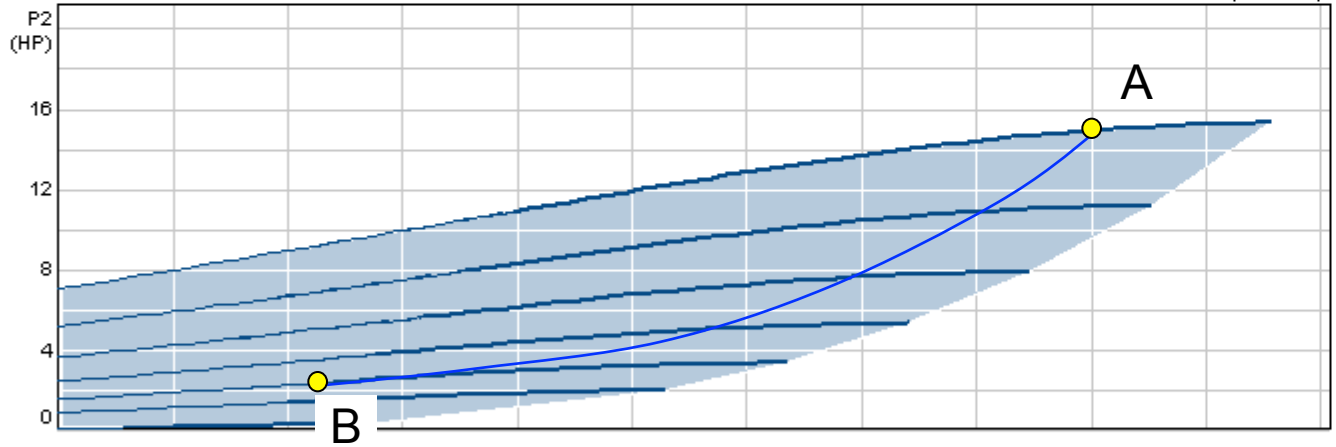
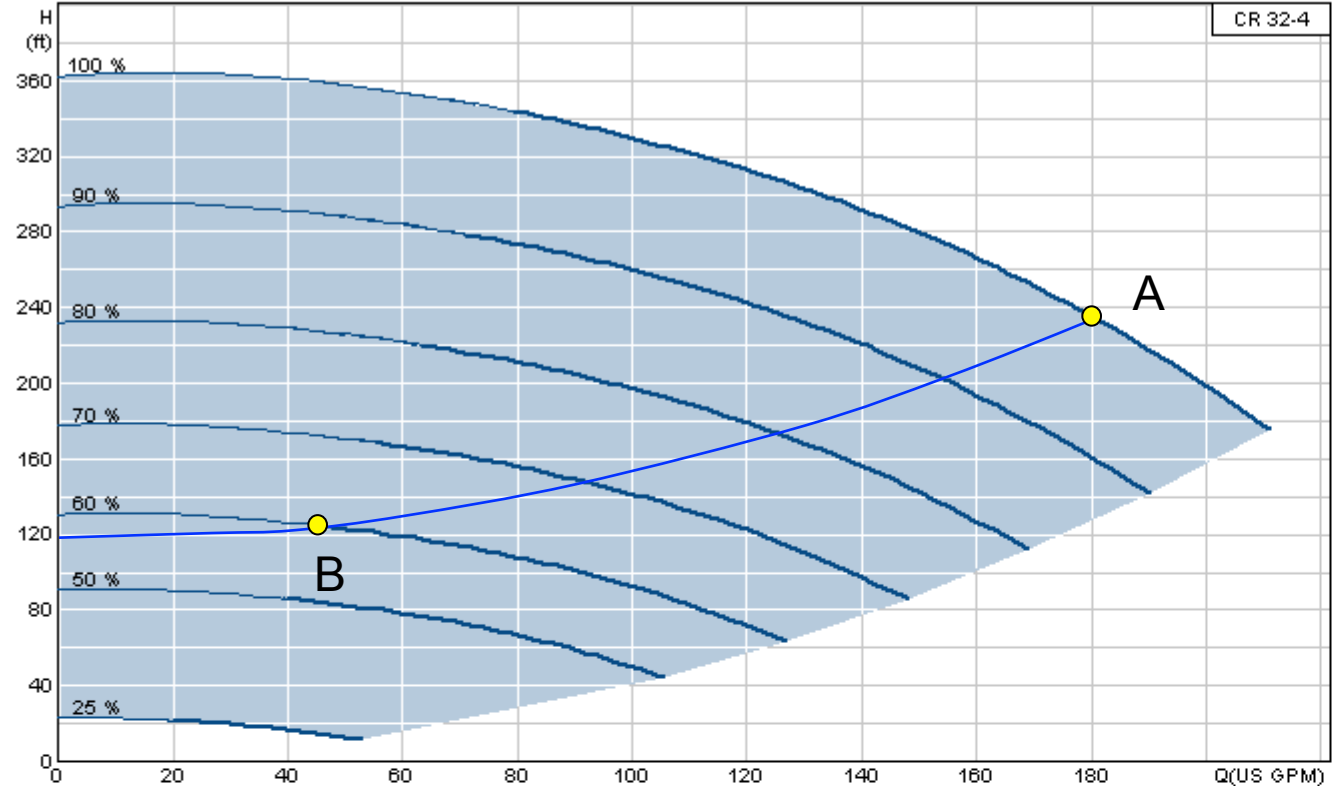

Speed and Torque reduction with **proportional** pressure control

Point A

Full Speed

180 gpm @ 235 feet

BHP = 15

RPM = 3450

Torque = 22.8 lb-ft

Point B

Speed reduced to 60%

45 gpm @ 127 feet

BHP = 2.4

RPM = 2070

Torque = 6.1 lb-ft

Equation for torque

$$T = \frac{HP \times 5250}{RPM}$$

Speed has been reduced by 40% but Torque has been reduced by **73%**

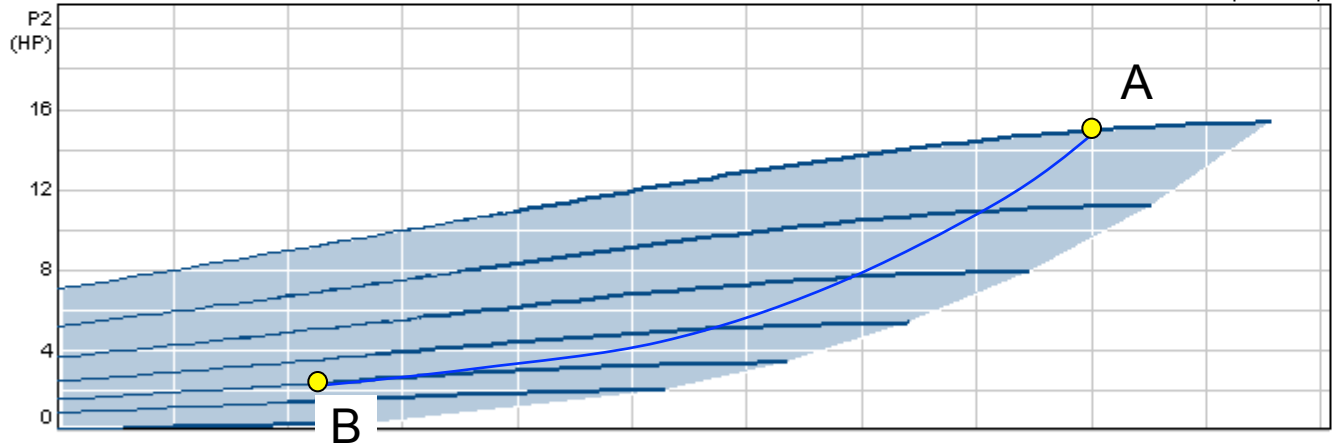
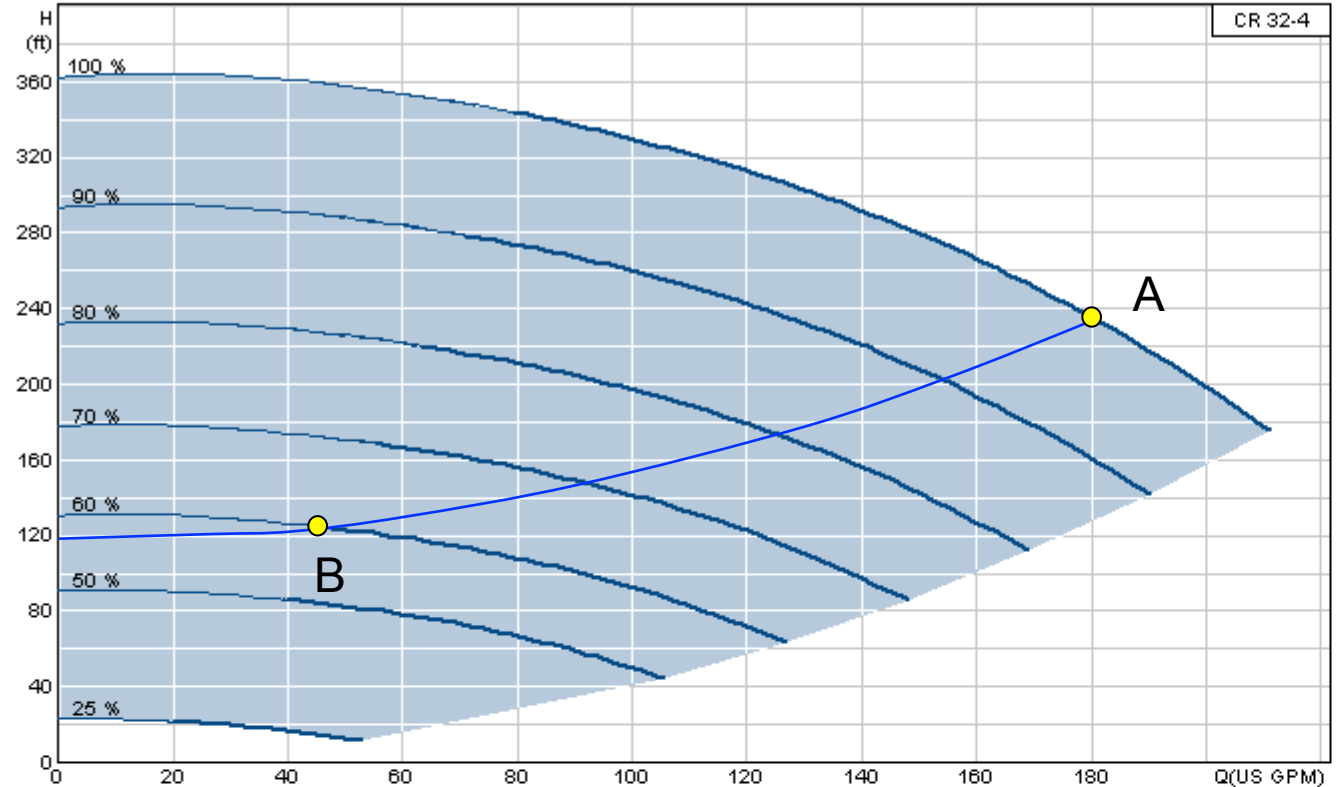

So what have we learned from these examples?

What defines an Inverter Duty Motor?

From project specifications we have seen

“Motors shall be...”

- Inverter Duty
- Inverter Duty rated
- Inverter Rated
- Inverter Ready

What defines an Inverter Duty Motor?

From project specifications we have seen

“Motors shall be...”

- Inverter Duty
- Inverter Duty rated
- Inverter Rated
- Inverter Ready

Interesting Fact:

The term “Inverter Duty” does not appear anywhere, not one single time, in the NEMA standards for motors (MG1).

Therefore the term “Inverter Duty” is not defined.

What defines an Inverter Duty Motor?

National Electrical Manufacturers Association (NEMA)

- **NEMA Standards Publication MG 1 – 2016**
 - **Part 31**
DEFINITE-PURPOSE INVERTER-FED POLYPHASE MOTORS

What defines an Inverter Duty Motor?

National Electrical Manufacturers Association (NEMA)

- NEMA Standards Publication **MG 1 – 2016**
 - **Part 31**
DEFINITE-PURPOSE INVERTER-FED POLYPHASE MOTORS
 - **Part 30**
APPLICATION CONSIDERATIONS FOR CONSTANT SPEED MOTORS USED ON A SINUSOIDAL BUS WITH HARMONIC CONTENT AND GENERAL PURPOSE MOTORS USED WITH **ADJUSTABLE-VOLTAGE OR ADJUSTABLE-FREQUENCY CONTROLS OR BOTH**

Usual Service Conditions

NEMA MG1 – 2016 Defines Usual Service Conditions as:

- a. Exposure to an ambient temperature in the range of **-15°C to 40°C** or, when water cooling is used, an ambient temperature range of 5°C (to prevent freezing of water) to 40°C, except for machines rated less than 3/4 hp and all machines other than water cooled having commutator or sleeve bearings for which the minimum ambient temperature is 0°C
- b. Exposure to an altitude which does not exceed **3300 feet** (1000 meters)
- c. Installation on a rigid mounting surface
- d. Installation in areas or supplementary enclosures which do not seriously interfere with the ventilation of the machine
- e. For medium motors
 - 1) V-belt drive in accordance with 14.67
 - 2) Flt-belt, chain and gear drives in accordance with 14.7

NEMA MG 1 Part 30

THE EFFECT OF REDUCED COOLING ON THE TORQUE CAPABILITY AT REDUCED SPEEDS OF 60 HZ NEMA DESIGN A AND B MOTORS

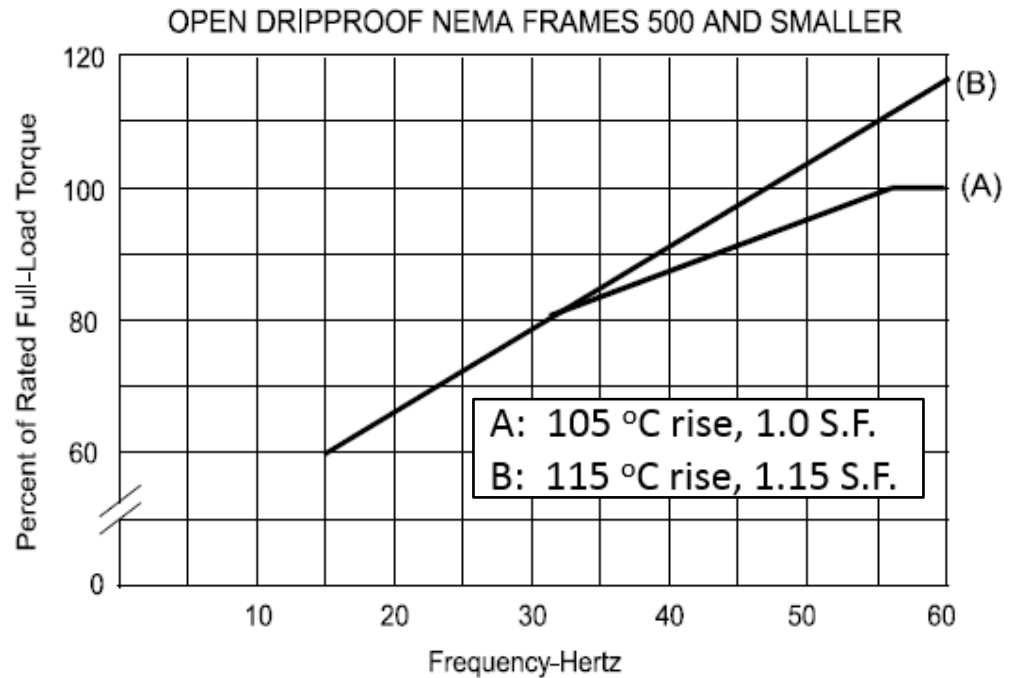

TOTALLY ENCLOSED FAN-COOLED NEMA FRAMES 500 AND SMALLER

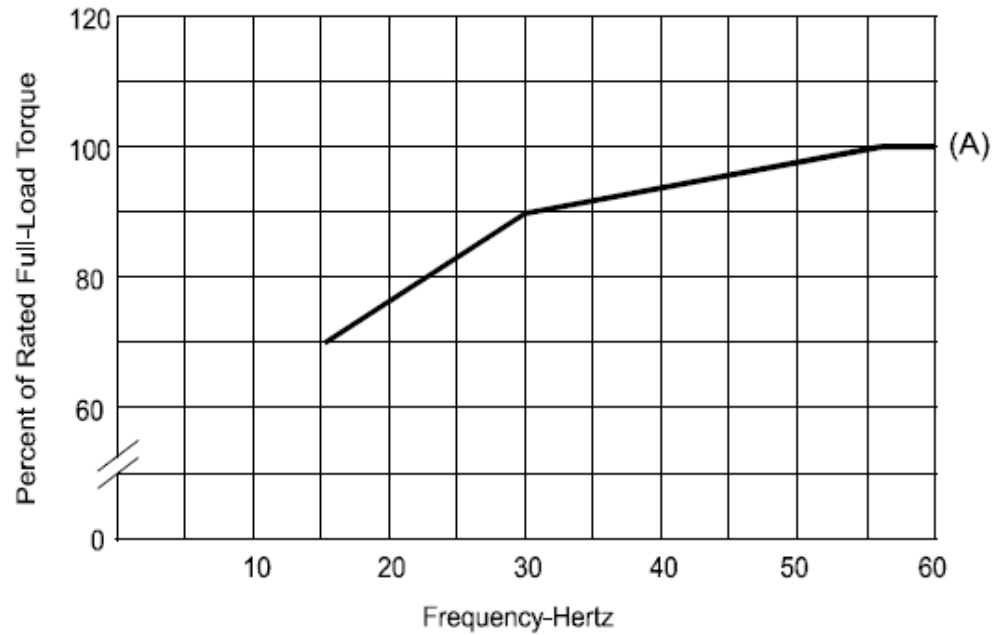

NEMA MG 1 Part 30

THE EFFECT OF REDUCED COOLING ON THE TORQUE CAPABILITY AT REDUCED SPEEDS OF 60 HZ NEMA DESIGN A AND B MOTORS

From previous example required torque from the pump was reduced from 22.8 to 6.1 lb-ft or only 27% of the original at 60% speed (36 Hz)

At 36Hz the percent of rated full load torque available ranges from 84 to 92%)19.2 to 21.0 lb-ft) which is well above the required 27% torque.

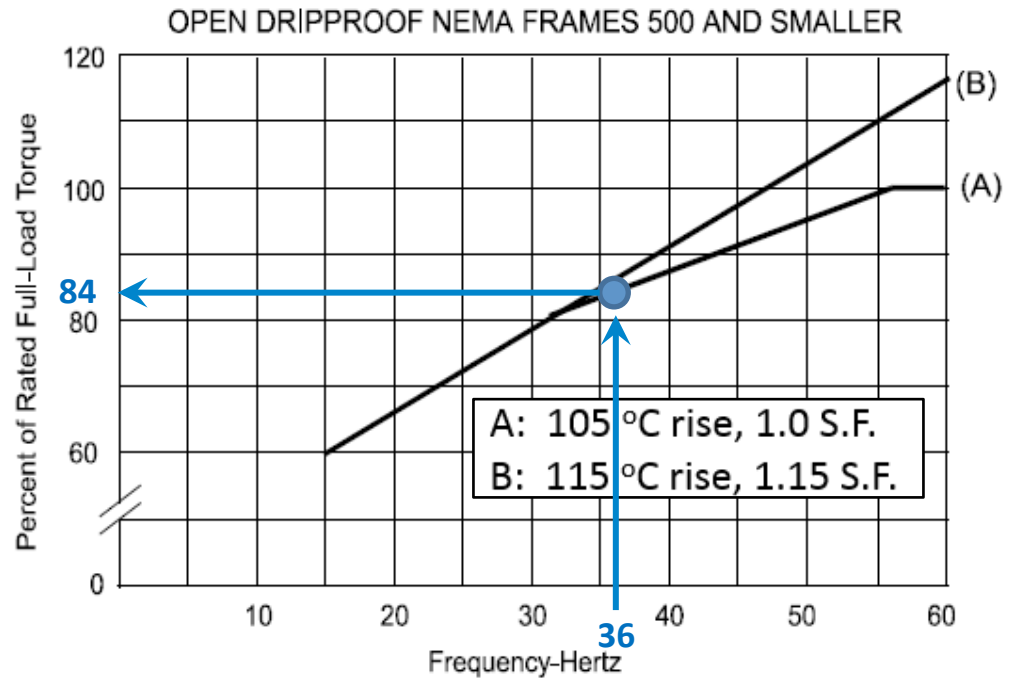

TOTALLY ENCLOSED FAN-COOLED NEMA FRAMES 500 AND SMALLER

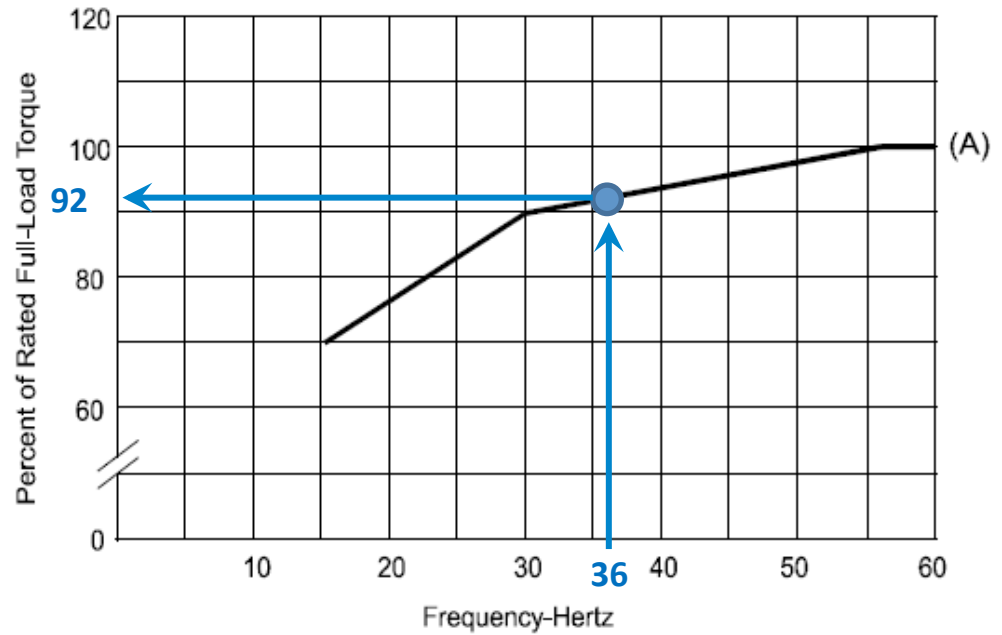

Voltage Stress

(Voltage Overshoot)

Voltage Stress

NEMA MG1 Part 30 (30.2.2.8)

The exact quantitative effects of peak voltage and rise time on motor insulation are not fully understood.

It can be assumed that when the motor is operated under **usual service conditions** there will be no significant reduction in service life due to voltage stress, if the following voltage limit values at the motor terminals are observed.

Motors with base rating voltage $V_{\text{rated}} \leq 600$ volts

$$V_{\text{peak}} \leq 1 \text{ kV}$$

$$\text{Rise time} \geq 2 \mu\text{s}$$

NEMA MG1 Part 31 (31.4.4.2)

Motors with base rating voltage $V_{\text{rated}} \leq 600$ volts

$$V_{\text{peak}} \leq 3.1 \times V_{\text{rated}}$$

$$\text{Rise time} \geq 0.1 \mu\text{s}$$

Voltage Stress

NEMA MG1 Part 30 (30.2.2.8)

The exact quantitative effects of peak voltage and rise time on motor insulation are not fully understood.

It can be assumed that when the motor is operated under **usual service conditions** there will be no significant reduction in service life due to voltage stress, if the following voltage limit values at the motor terminals are observed.

Motors with base rating voltage $V_{\text{rated}} \leq 600$ volts

$$V_{\text{peak}} \leq 1 \text{ kV}$$

MG1, Part 30 = 1000 Volts

$$\text{Rise time} \geq 2 \mu\text{s}$$

NEMA MG1 Part 31 (31.4.4.2)

Motors with base rating voltage $V_{\text{rated}} \leq 600$ volts

$$V_{\text{peak}} \leq 3.1 \times V_{\text{rated}}$$

$3.1 \times 480 = 1488$, MG1, Part 31 = 1488 Volts

$$\text{Rise time} \geq 0.1 \mu\text{s}$$

Switching Frequency (aka Carrier or PWM frequency)

Characteristics of the Three Controls		
Control	Default Switching Frequency (kHz)	Rise Time (ns)
A	4.5	458
B	4.8	130
C	15	35

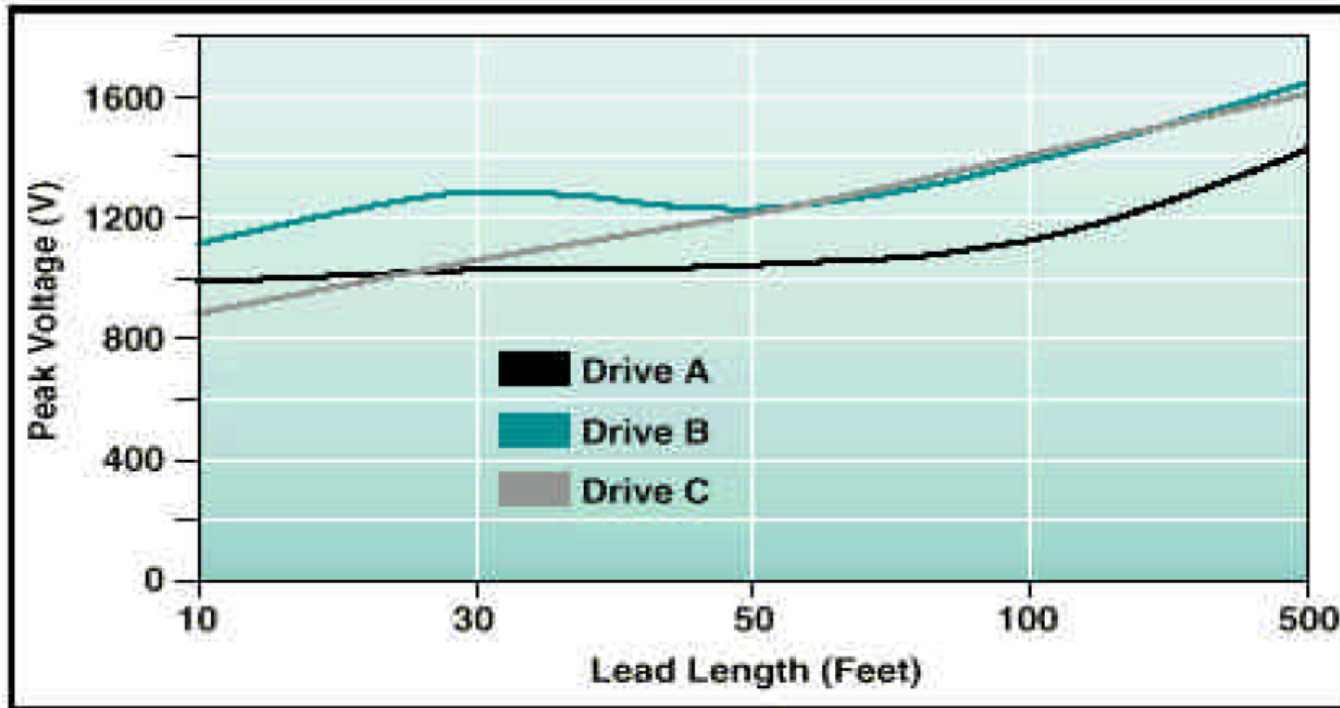

Source: NEMA Standards Publication MG 1 – 2016

Cable lengths: Test data from drive manufacturer

40 HP

Motor lead length	Input Voltage	Rise time	Peak Voltage
50 ft	230 V	0.194 msec	626 V
500 ft	230 V	0.488 msec	538 V
80 ft	480 V	0.264 msec	1150 V
500 ft	480 V	0.400 msec	1225 V

75 HP

Motor lead length	Input Voltage	Rise time	Peak Voltage
16 ft	480 V	0.256 msec	1230 V
165 ft	480 V	0.328 msec	1200 V
500 ft	480 V	0.960 msec	1150 V

Note: Most motors are dual voltage 230/460 where the windings are designed for a peak voltage of 1000 to 1600 volts so using 230 volt power will be easier on the windings.

Tips for avoiding motor damage due to Voltage Stress (Overshoot)

- Use lower voltage supply (230 volts instead of 460 volts)
- Run Control as lowest carrier frequency possible
- Avoid running multiple motors from the same drive
 - If you must, connect each motor directly to the drives output terminals and avoid “daisy chaining” the motors to each other
- Determine the probable lead length, rise time and switching frequency to select the correct motor.
- If the lead length will be long and the rise time will be short etc. output filters can be installed between the drive and motor.

Tips for avoiding motor damage due to Voltage Stress (Overshoot)

- Use lower voltage supply (230 volts instead of 460 volts)
- Run Control as lowest carrier frequency possible
- Avoid running multiple motors from the same drive
 - If you must, connect each motor directly to the drives output terminals and avoid “daisy chaining” the motors to each other
- Determine the probable lead length, rise time and switching frequency to select the correct motor.
- If the lead length will be long and the rise time will be short, output filters can be installed between the drive and motor.

NEMA Standards Publication

Application Guide For AC Adjustable Speed Drive Systems

www.nema.org

Guidelines for specifying motors driven by variable frequency drives

Specify Definite-Purpose Inverter-Fed polyphaser motors built to NEMA MG1, Part 31 when:

- **Constant Torque** with a turndown ratio greater than 20:1 is required
- Encoder feedback for precise speed regulation is required
- Peak voltages will exceed 1000 volts and motor windings to not meet NEMA MG1 - 31.4.4.2

Specify General Purpose motors built to NEMA MG1, Part 30 when:

- Variable Torque with a turndown ratio less than 20:1 is required
- Full load torque at full speed is required
- Peak Voltage will not exceed 1000V or motor windings meet 31.4.4.2

Guidelines for specifying motors driven by variable frequency drives ...*made*

simple

For most centrifugal pump applications, specify a NEMA Premium Efficiency class motor (or better). Almost every motor manufacturer builds their NEMA Premium class motors with these features:

- Windings that meet the peak voltage requirements of MG1 part 31.4.4.2
- Insulation Class F or H (designed to withstand a high temperature rise)
- Temperature rise of Class B (designed to produce a low temperature rise)

Guidelines for specifying motors driven by variable frequency drives ...*made simple*

For most centrifugal pump applications, specify a NEMA Premium Efficiency class motor (or better). Almost every motor manufacturer builds their NEMA Premium class motors with these features:

- Windings that meet the peak voltage requirements of MG1 part 31.4.4.2
- Insulation Class F or H (designed to withstand a high temperature rise)
- Temperature rise of Class B (designed to produce a low temperature rise)

**Table 31-2
TEMPERATURE RISE**

Insulation Class	Maximum Intermittent Winding Temperature Rise Degrees C		Relative Equivalent Temperature Rise (T_E) Degrees C	
	Method of Temperature Determination		Method of Temperature Determination	
	Resistance	Embedded Detector	Resistance	Embedded Detector
A	70	80	60	70
B	100	110	80	90
F*	130	140	105	115
H*	155	170	125	140

* Where a Class F or H insulation system is used, special consideration should be given to bearing temperature, lubrication etc.

Electric Motor Efficiency Standards

<u>NEMA Motor Efficiency</u>	<u>Similar IEC Designation</u>
Below Energy Efficient	IE1
Energy Efficient	IE2
NEMA Premium	IE3

Electric Motor Efficiency Standards

<u>NEMA Motor Efficiency</u>	<u>Similar IEC Designation</u>
Below Energy Efficient	IE1
Energy Efficient	IE2
NEMA Premium	IE3
“Super” Premium (not officially defined)	IE4
?????	IE5

Electric Motor Efficiency Standards

<u>NEMA Motor Efficiency</u>	<u>Similar IEC Designation</u>
Below Energy Efficient	IE1
Energy Efficient	IE2
NEMA Premium	IE3
“Super” Premium (not officially defined)	IE4
?????	IE5



Motor Efficiency Comparison

(3500 RPM - Enclosed)

HP	TEFC Motor + Conventional VFD			60034-30-2	
	IE3/NEMA Premium Efficiency	Typical VFD Efficiency	Combined Motor+VFD Efficiency	IE4 Efficiency	IE5 Efficiency
2	85.5	97.0	82.9	86.5	88.9
3	86.5	97.0	83.9	88.0	90.2
5	88.5	97.0	85.8	89.1	91.1
7.5	89.5	97.0	86.8	90.9	92.6
10	90.2	97.0	87.5	91.7	93.3
15	91.0	98.0	89.2	92.6	94.0

Current trends

- Motor mounted drives
 - Minimize peak voltages due to short cables from drive to motor
 - Lower installation cost
 - Manufacturer matches drive to motor, motor to pump
 - Highly integrated (motor+drive same manufacturer)

- ECM (Electronically Commutated Motor)
 - Permanent Magnets
 - No magnetic losses, higher Eff. than Premium
 - Above Premium efficiency levels (IE4, IE5)
 - Smaller physical size (Higher Flux Density)



Motor mounted VFD



Motor mounted VFD
(Integrated)

Motor Efficiency Comparison

(3500 RPM - Enclosed)

HP	TEFC Motor + Conventional VFD					Integrated	
	IE3/NEMA Premium Efficiency	Typical VFD Efficiency	Combined Motor+VFD Efficiency	60034-30-2 IE4 Efficiency	60034-30-2 IE5 Efficiency	IE5 Motor + VFD Efficiency	Increase over IE3 Motor+VFD
2	85.5	97.0	82.9	86.5	88.9	89.4	6.5
3	86.5	97.0	83.9	88.0	90.2	90.7	6.8
5	88.5	97.0	85.8	89.1	91.1	92.5	6.7
7.5	89.5	97.0	86.8	90.9	92.6	92.4	5.6
10	90.2	97.0	87.5	91.7	93.3	92.5	5.0
15	91.0	98.0	89.2	92.6	94.0	93.2	4.0

Shaft Voltages and Bearing Currents

Recommendations to Avoid Detrimental Effects of Shaft Voltages and Bearing Currents

- Ensure motor and drive are properly grounded
- Run at lowest carrier frequency possible
- Use shaft grounding device
- Use common mode filter (to reduce common mode voltage)
- Use insulated bearings
- **Operate at lower voltage (230 vs 460 etc.)**
Simply specifying a motor to meet NEMA MG1 Part 31 does not make a motor immune to damage from shaft voltages and bearing currents

- Ensure motor and drive are properly grounded
- Run at lowest carrier frequency possible
- Use shaft grounding device
- Use common mode filter (reduce common mode voltage)
- Use insulated bearings
- Operate at lower voltage (230 vs 460 etc.)

Grundfos Technical Institute



Thank you!

www.grundfos.us/training

Is the motor with the word “Inverter” on the nameplate worth the added cost?

BALDOR • RELIANCE®
SuperE Motor

CAT. NO.	85600H24										
SPEC.	09G939Z602G1										
HP	15										
VOLTS	208-230/460										
AMPS	38-35/17.5										
R.P.M.	3520										
FRAME	254TCZ	HZ	60	PH	3						
SER. F.	1.15	CODE	G	DES.	B	CLASS	F				
NEMA NOM. EFF.	91	%	P.F.	87	%						
RATING	40C AMB-CONT										
CC	USABLE AT 208V								A		
BEARINGS	DE	7309	ODE	6208							
ENCL	TEFC	SN	Z1604080169								
SFA 44-40/20											

NEMA Premium
Energy Verified MC 183051

BALDOR ELECTRIC CO. FT. SMITH, AR. MFG. IN U.S.A.
NP1259L

BALDOR • RELIANCE®
INVERTER DRIVE MOTOR

CAT. NO.	84Z03682									
SPEC.	09S019X764G2									
FRAME	254TC	H.P.	15	TE						
VOLTS	230/460									
MAG. CUR.	10.8/5.4					34.4/17.2				
R.P.M.	3510					R.P.M. MAX	5000			
HZ.	60	PH.	3	CLASS	H					
SER. F.	1.00	DES.	B	SL HZ	1.4					
NEMA NOM. EFF.	91	WK ²	0.77							
BLOWER	V	PH	HZ							
RATING	40C AMB-CONT									
BEARINGS	DE	6410	ODE	6208						
CC	010A	SN	Z1605050252							

F.L. AMPS
LB FT²
AMPS

NEMA Premium
Energy Verified MC 183051

BALDOR ELECTRIC CO. FT. SMITH, AR. MFG. IN U.S.A.
NP1163L

Unusual Service Conditions

- a. Exposure to:
 - 1) Combustible, explosive, abrasive, or conducting dusts
 - 2) Lint or very dirty operating conditions where the accumulation of dirt may interfere with normal ventilation
 - 3) Chemical fumes, flammable or explosive gases
 - 4) Nuclear radiation
 - 5) Steam, salt-laden air, or oil vapor
 - 6) Damp or very dry locations, radiant heat, vermin infestation, or atmospheres conducive to the growth of fungus**
 - 7) Abnormal shock, vibration, or mechanical loading from external sources
 - 8) Abnormal axial or side thrust imposed on the motor shaft
 - 9) A coupling mass that is greater than 10% of rotor weight and/or has a center of gravity that is beyond the shaft extension
 - 10) A Coupling or coupling/coupling guard combination which could produce a negative pressure at the drive end seal
- b. Operation where:
 - 1) Low noise levels are required
 - 2) The voltage at the motor terminals is unbalanced by more than one percent**
- c. Operation at speeds above the highest rated speed
- d. Operation in a poorly ventilated room, in a pit, or in an inclined position**
- e. Operation where subjected to:
 - 1) Torsional impact loads
 - 2) Repetitive abnormal overloads
 - 3) Reversing or electric braking
- f. Belt, gear, or chain drives for machines not covered by 31.1.2e
- g. Multi-motor applications:

Special consideration must be given to applications where more than one motor is used on the same control. Some of these considerations are:

 - 1) Possible large variation in load on motors where load sharing of two or more motors is required
 - 2) Protection of individual motors
 - 3) Starting or restarting of one or more motors
 - 4) Interaction between motors due to current perturbations caused by differences in motor loading

Typical Single Stage Pump Curve

